



# DATRON DENTAL - MILLING TOOLS

Carbide milling tools for all standard dental CNC milling machines and materials



Standard range for open milling systems



DATRON  
D1 pure

Robocam

R+K CAD/CAM  
Technologie

Röders

Roland



DATRON D5

Wissner

Willemin Macodel

Pou Chen Group

Hermie

BZT Dental

DMG

GF Agie Chamilles

Primacon

Cimt Pi5

Hint Els

Laserdenta

MB

Zfc™ inhouse 5x

**Quality and Precision  
"Made in Germany":**

Our decades of experience in the manufacture of milling tools combined with state-of-the-art fully automatic machines in our in-house grinding plant results in the consistently high precision and quality of DATRON milling tools, all without exception Made in Germany.

**DATRON technology**

Our active DATRON expertise in the field of HSC milling (high-speed cutting) extends back as far as 1988. The continuing development and optimisation of our closely linked technologies guarantee you tools proven in practice that are the state of the art in technology.

**Economy**

The use of high-quality carbide in ultra-fine-grain quality continuously matched to the specific applications ensures that you experience particularly long tool life with DATRON milling tools.

**Customised tool  
& regrinding service**

We manufacture customised carbide tools to your specifications in the best DATRON quality. Extend the value of your tools with our professional regrinding service!

# Standard range for open milling systems

---

Ball nose end mill		15
Spherical		18
End mill		19
Toric end mill		22
Drill	<b>cobalt-chrome/ titanium</b>	26
Centring drill		28
High-precision tools		29
Seat milling cutter		32

---

Ball nose end mill		35
Spherical	<b>zirconia</b>	39
End mill		40

---

Ball nose end mill with one flute	<b>PMMA/ wax</b>	43
Ball nose end mill		44

---

Ball nose end mill	<b>composites</b>	49
--------------------	-------------------	----

---

**Your success is based on our team**

Our approximately 290 enthusiastic and motivated employees are working every day for customers around the world. We have thousands of customers for our tools as our regular customers.

Your demand for quality motivates us.

**Innovative power made in Germany**

The selection of suitable high-quality tools is the essential component for success in dental milling in the micrometre range. Our experienced engineers and grinding specialists have developed precision milling tools for the special requirements of milling dental materials that are not only specially designed for current CAD/CAM systems but are also noted for particularly long tool life.



## Success with DATRON Dental milling tools - now and into the future

The manufacture of dental milling tools on state-of-the-art fully automatic grinding machines ensures consistently high quality and performance for your manufacturing process. Our carbide milling tools are not only compatible with DATRON milling machines but also a wide range of machines from other manufacturers. However, if you require a special tool that you can't find in our standard range, we can offer you

the option of manufacturing individual end mills to your own specifications. Specially optimised for high-speed milling, the high-quality coatings, such as diamond or high-end coatings developed and refined in our company, are particularly wear-resistant.

### DATRON Dental Milling Tools

- 100% availability at the [webshop.datron.de](http://webshop.datron.de)
  - Unbeatable price-performance ratio
  - Ultra-fine-grain carbide tools
  - Special coatings ensure above-average tool life
  - For all standard dental milling machines and materials
- Maximum surface quality of milled indications  
Manufacture of specialised and custom milling tools  
Worldwide distribution network - fast delivery



**Do you need a special tool?  
Not a problem for DATRON!**

DATRON milling tools are also compatible with the systems of a very wide range of different manufacturers. Users of CAD/CAM systems supplied by the manufacturers listed in the catalogue already use DATRON milling tools. Customer feedback confirms the superior tool life of the milling tools, the outstanding quality of the milling results and the unbeatable price-performance ratio.

If you work with a CAD/CAM system from a manufacturer that is not listed in our catalogue, please contact us.

We are able to offer solutions specifically for your machines. We can also manufacture specialised and customised tools to your specifications.

Please contact us by email at **cct@datron.de** or by telephone at **+49 (0) 6151 1419-480**.

Designation	Your individual data
<b>Milling tool comparable with item number</b>	
<b>D1</b> flute diameter	
<b>D2</b> shank diameter	
<b>D3</b> diameter shank toric	
<b>L1</b> total length	
<b>L2</b> useable flute length	
<b>L3</b> useable length	
<b>R</b> radius	
<b>BS</b> coating	

### Strong cutting for strong teeth

Dental technicians can manufacture particularly wear-resistant dentures from zirconium oxide, which with its high bending and tensile strength along with its mechanical stability requires equally strong milling tools for machining it. The DATRON diamond coating in the Premium segment with a Vickers hardness of 10,000 HV and a friction value of 0.15 with maximum tool life is guaranteed for this task.

DATRON also offers the established high-end state-of-the-art coatings in the Quality segment with equally good wear resistance, excellent bonding effect and high density for the best cutting quality. The uncoated milling tools in the Basic segment are noted for particularly sharp cutting and optimised cutting geometries.

### Different high-end coatings







## DATRON HIGH FEED END MILL

The new "DATRON high feed end mill" type of milling tool adds high-performance milling tools with the latest technological parameters to our portfolio. DATRON high feed end mills come with the DATRON special coating and are ideal for the manufacture of all indications where time and quality are important.

The new DATRON high feed end mill has been specially developed for high-speed machining of cobalt chrome and titanium. The innovative 3-flute geometry combined with the DATRON high feed end mill dental coating makes it particularly suited for technical high-performance.

You get high precision combined with higher feeds, shorter process times, minimum wear and reduced heat development when milling hard alloys and materials.

### Your benefits at a glance:

- Specially adapted 3-flute geometry
- High machining performance
- Maximum precision when milling CoCr and titanium
- Long tool life, resistant to oxidation and thermal stability



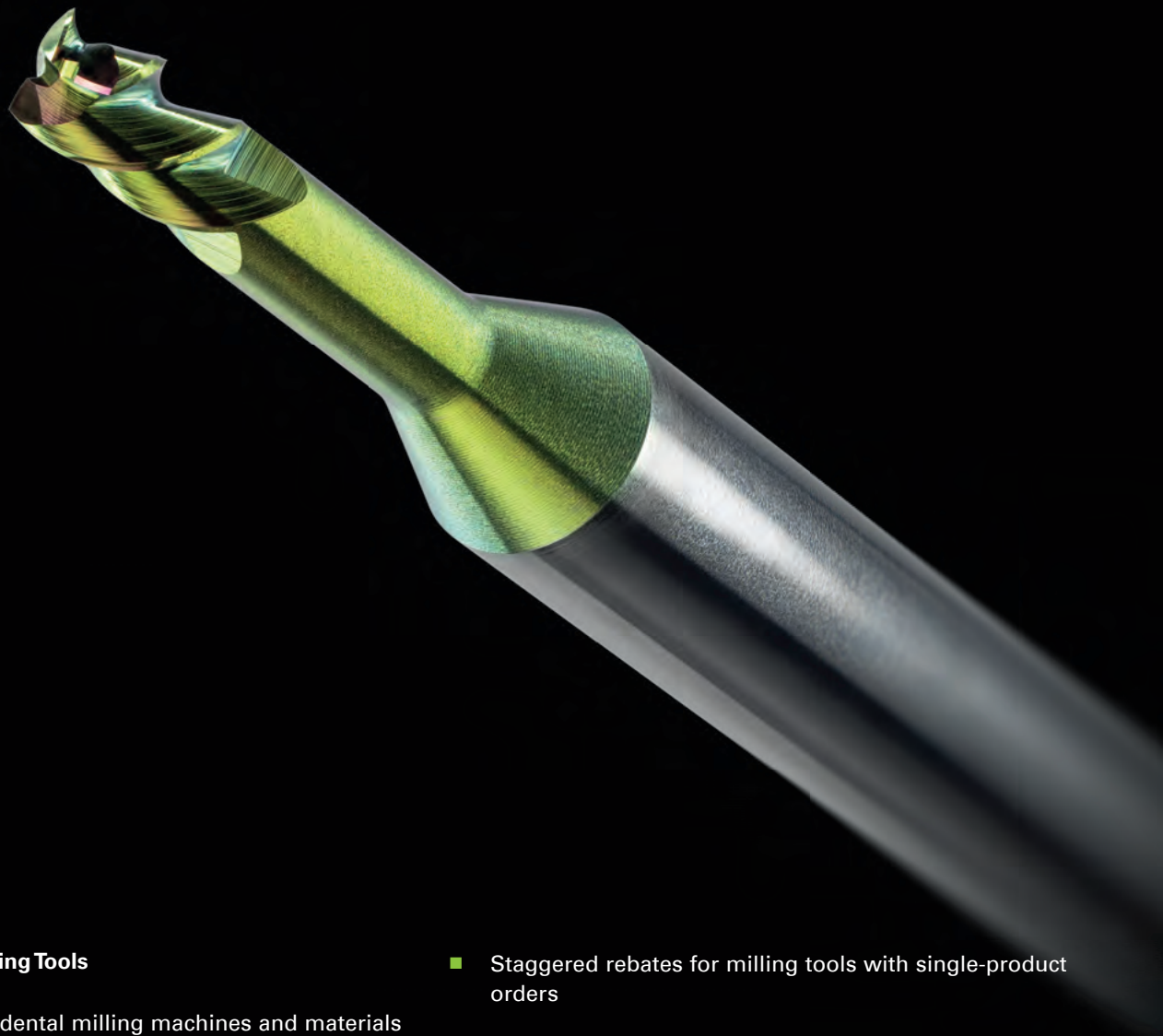

### DATRON Dental Milling Tools

- For all standard dental milling machines and materials
- Top tool life and quality with excellent price-performance ratio
- Maximum surface quality of milled indications
- Wide range and 100% availability
- Manufacture of specialised and custom milling tools
- All milling tools available separately
- Staggered rebates for milling tools with single-product orders
- 4% discount for direct debit authorisation  
Please contact [rechnungswesen@datron.de](mailto:rechnungswesen@datron.de) if you have any questions about a direct debit authorisation
- Delivery anywhere in Germany on work days generally with the next 24 hours without surcharge for order received by 2:30 pm
- Worldwide distribution network

**Compatibility - with (almost) all dental milling systems**



**Machinable materials**



**Flute number**



**Micro-grain**



**Spiral angle**



**Machining direction**



**Shank shape**



**Ball nose**



**Sharp-edged flute**



**Flute with edge radius**



**Diamond flute**



**Spherical (lollipop)**



**Cooling (wet/dry machining)**



**Tip angle**



**Limit stop ring**

<b>D1</b>	<b>Flute diameter</b>
<b>D2</b>	<b>Shank diameter</b>
<b>D3</b>	<b>Shank toric diameter</b>
<b>L1</b>	<b>Total length</b>
<b>L2</b>	<b>Useable flute length</b>
<b>L3</b>	<b>Toric cut length</b>
<b>α</b>	<b>Angle</b>
<b>R</b>	<b>Radius</b>
<b>BS</b>	<b>Coating</b>

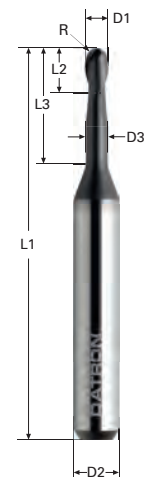

DATRON Dental milling tools have been designed for all current dental materials. The new colour-coding shows the type at a glance.

**cobalt-chrome/  
titanium**

**Jelly Purple**

**non-precious metal**

**zirconia**

**Bubblegum Pink**

**PMMA/  
wax**

**Honey Nut Yellow**

**composites**

**Spearmint Green**

## We also supply milling tools for machine-specific milling systems

Our continuous intensive research and development guarantees you maximum tool life, precision and aesthetic results. Our carbide milling tools are not only compatible with universal milling systems but also with a wide range of machine-specific milling systems. For detailed information see [webshop.datron.de](http://webshop.datron.de).

The list of compatible milling systems will convince you:

### Standard range for machine-specific milling systems

Amann Girrbach

Roland

Zirkonzahn

DCS

Sirona

Degudent

VHF

imes-icore

Yenadent



# DATRON tools: the dental concept for long life, quality and precision

Our tool experts are familiar with demanding milling concepts. We advise dental technicians all around the world about the machining of all types of dental materials from cobalt chrome and titanium to zirconium oxide through to PMMA and wax. Our DATRON Dental standard tools are not only specially designed for DATRON milling machines but they are also compatible with all standard systems from other manufacturers.

Only components that are optimally matched to one another enable precisely fitted aesthetic results with challenges of all types in dentistry.

Find the proven dental milling tools for your tasks that meet the highest possible quality requirements.

<b>DATRON</b> D1 pure	<b>DATRON D5</b>	<b>BZT Dental</b>	<b>Hint Els</b>
<b>Robocam</b>	<b>Wissner</b>	<b>DMG</b>	<b>Laserdenta</b>
<b>R+K Organical CAD/CAM</b>	<b>Willemin Macodel</b>	<b>GF Agie Chamilles</b>	<b>MB Cobra Mill Systems</b>
<b>Röders</b>	<b>Pou Chen Group</b>	<b>Primacon</b>	<b>Zfx™ inhouse 5x</b>
<b>Roland</b>	<b>Hermle</b>	<b>Cimt Pi5</b>	

## CAM software

<b>Dental Softworks</b>	<b>WORKNC Dental</b>	<b>hyperDENT</b>	<b>SUM3D Dental, MillBox</b>
-------------------------	----------------------	------------------	------------------------------

Please contact us by email at [cct@datron.de](mailto:cct@datron.de) or by telephone at +49 (0) 6151 1419-480.



# DATRON milling tools for cobalt-chrome/titanium

- Ball nose end mill
- Spherical (lollipop)
- End mill
- Toric end mill
- Drill
- High-precision tools  $\pm 5 \mu$
- Seat milling cutter (incl. NPM)

CoCr

titanium



**Ball nose end mill**  
from page 15



**Spherical**  
from page 18



**End mill**  
from page 19



**Toric end mill**  
from page 22



**Drill**  
from page 26



**Conical centring bush**  
from page 28



**High-precision tools**  
from page 29



**Seat milling cutter**  
from page 32



## Ball nose end mill for cobalt-chrome/titanium

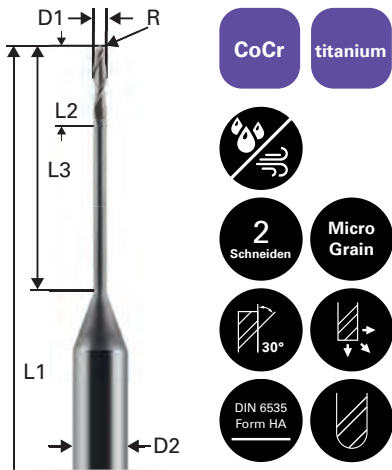

**End mill type:** Ball nose end mill, double flute, coated

**Features:** High coating hardness specially designed for hard materials that are difficult to mill

**Indications:** Copings, crowns (anatomic, anatomically reduced), bridges, bars, individual abutments, screw-retained restorations, 3D free-form surfaces

cobalt-chrome/  
titanium

3 mm shank, short neck

	Item no.	D1 (mm)	D2 (mm)	D3 (mm)	L1 (mm)	L2 (mm)	L3 (mm)	R (mm)	BS
	00784004	0.40	3.00		39.00	1.20		0.20	x
	00784010	0.50	3.00		39.00	1.50		0.25	x
	00784006	0.60	3.00		39.00	1.80		0.30	x







cobalt-chrome/  
titanium

3 mm shank, long neck

	Item no.	D1 (mm)	D2 (mm)	D3 (mm)	L1 (mm)	L2 (mm)	L3 (mm)	R (mm)	BS
	00782303	0.30	3.00	0.28	39.00	0.60	2.50	0.15	x
	00782305	0.50	3.00	0.45	39.00	0.75	4.00	0.25	x
	00782308	0.80	3.00	0.75	39.00	3.50	8.00	0.40	x
	00782310	1.00	3.00	0.95	39.00	3.00	8.00	0.50	x
	00782315	1.50	3.00	1.45	39.00	4.00	12.00	0.75	x
	00782320	2.00	3.00	1.90	39.00	3.50	14.00	1.00	x
	00782330	3.00	3.00	2.80	39.00	5.50	15.00	1.50	x







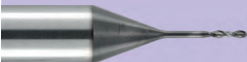

cobalt-chrome/  
titanium

4 mm shank, long neck

	Item no.	D1 (mm)	D2 (mm)	D3 (mm)	L1 (mm)	L2 (mm)	L3 (mm)	R (mm)	BS
	00784408	0.80	4.00	0.75	50.00	3.00	10.00	0.40	x
	00784410	1.00	4.00	0.95	50.00	3.50	12.00	0.50	x
	00784415	1.50	4.00	1.45	50.00	4.00	14.00	0.75	x
	00784420	2.00	4.00	1.90	50.00	4.50	16.00	1.00	x
	00784425	2.50	4.00	2.35	50.00	5.00	18.00	1.25	x
	00784430	3.00	4.00	2.80	50.00	5.50	22.00	1.50	x



cobalt-chrome/  
titanium

6 mm shank, long neck

	Item no.	D1 (mm)	D2 (mm)	D3 (mm)	L1 (mm)	L2 (mm)	L3 (mm)	R (mm)	BS
	00782603	0.30	6.00	0.28	50.00	0.60	2.50	0.15	x
	00782608	0.80	6.00	0.75	50.00	3.50	8.00	0.40	x
	00782610	1.00	6.00	0.95	50.00	3.00	8.00	0.50	x
	00782611	1.00	6.00	0.95	50.00	3.00	10.00	0.50	x
	00782615	1.50	6.00	1.45	50.00	4.00	12.00	0.75	x
	00782620	2.00	6.00	1.90	50.00	3.50	12.00	1.00	x
	00782625	2.50	6.00	2.40	50.00	4.50	14.00	1.25	x
	00782630	3.00	6.00	2.80	50.00	5.50	15.00	1.50	x
	00782630L	3.00	6.00	2.80	50.00	5.50	17.00	1.50	x

cobalt-chrome/  
titanium

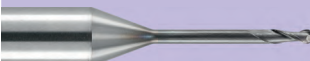
6 mm shank, Xtra long neck

	Item no.	D1 (mm)	D2 (mm)	D3 (mm)	L1 (mm)	L2 (mm)	L3 (mm)	R (mm)	BS
	00783610	1.00	6.00	0.95	50.00	3.00	12.00	0.50	x
	00783615	1.50	6.00	1.45	50.00	4.00	16.00	0.75	x
	00783620	2.00	6.00	1.95	50.00	3.50	16.00	1.00	x
	00783630	3.00	6.00	2.95	50.00	5.50	22.00	1.50	x

# Ball nose end mill for cobalt-chrome/titanium



- CoCr titanium
- 
- 2 Micro Grain
- 30°
- DIN 6535 Form HA

**End mill type:** Ball nose end mill, conical, coated

**Features:** Voluminous and robust tip with short useable length, which means reduced danger of head fracture

**Indications:** Surface finishes (fissures), edge machining, interdental spaces, internal machining (inside cavities)

cobalt-chrome/  
titanium

**3 mm shank**

	Item no.	D1 (mm)	D2 (mm)	D3 (mm)	L1 (mm)	L2 (mm)	L3 (mm)	R (mm)	BS
	0078236K	0.60	3.00		48.00	1.20		0.30	x

cobalt-chrome/  
titanium

**6 mm shank**

	Item no.	D1 (mm)	D2 (mm)	D3 (mm)	L1 (mm)	L2 (mm)	L3 (mm)	R (mm)	BS
	0078266K	0.60	6.00		50.00	1.20		0.30	x
	0078268K	0.80	6.00		50.00	1.60		0.40	x
	0078261K	1.00	6.00		50.00	2.00		0.50	x

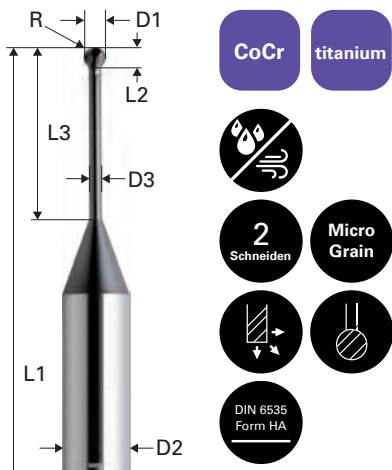

**End mill type:** Spherical (lollipop); double flute, coated

**Features:** High degree of machining options with undercuts without having to tilt the work piece

**Indications:** Undercut machining, outer contours, internal contours

cobalt-chrome/  
titanium

3 mm shank

Item no.	D1 (mm)	D2 (mm)	D3 (mm)	L1 (mm)	L2 (mm)	L3 (mm)	R (mm)	Ball (de- gree)	BS
00785310	2.00	3.00	1.10	48.00	1.84	14.00	1.00	270	x

cobalt-chrome/  
titanium

6 mm shank

Item no.	D1 (mm)	D2 (mm)	D3 (mm)	L1 (mm)	L2 (mm)	L3 (mm)	R (mm)	Ball (de- gree)	BS
00785610	2.00	6.00	1.10	50.00	1.84	14.00	1.00	270	x

## End mill for cobalt-chrome/titanium

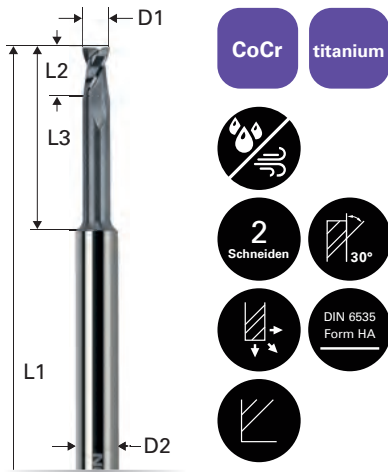

**End mill type:** End mill, double flute, with toric cut, coated

**Features:** Very sharp flutes, precision plane face machining, ideal for screw contact surfaces and/or contour machining

**Indications:** Bars, individual abutments, screw-retained restorations, interface connections (internal/external), screw contact surfaces

cobalt-chrome/  
titanium

3 mm shank, long neck

	Item no.	D1 (mm)	D2 (mm)	D3 (mm)	L1 (mm)	L2 (mm)	L3 (mm)	R (mm)	BS
	0078004L	0.40	3.00	0.35	48.00	0.50	4.50		x
	0078005L	0.50	3.00	0.45	48.00	0.60	5.00		x
	0078008L	0.80	3.00	0.75	48.00	1.00	8.00		x
	0078010L	1.00	3.00	0.95	48.00	1.20	15.00		x
	0078012L	1.20	3.00	1.15	48.00	1.40	15.00		x
	0078015L	1.50	3.00	1.40	48.00	1.80	16.00		x
	0078018L	1.80	3.00	1.70	48.00	2.20	16.00		x
	0078020L	2.00	3.00	1.90	48.00	2.40	16.00		x
	0078025L	2.50	3.00	2.40	48.00	3.00	18.00		x

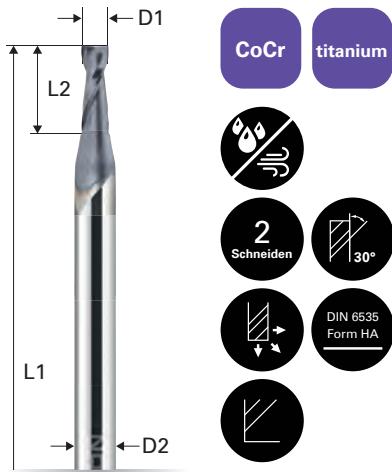

**End mill type:** End mill, double flute, coated

**Features:** Very sharp flutes, precision machining of flat surfaces, ideal for screw contact surfaces and/or contour machining

**Indications:** Bars, individual abutments, screw-retained restorations, interface connections (internal/external), screw contact surfaces

cobalt-chrome/  
titanium

3 mm shank

	Item no.	D1 (mm)	D2 (mm)	D3 (mm)	L1 (mm)	L2 (mm)	L3 (mm)	R (mm)	BS
	0078009K	0.90	3.00		38.00	1.80			x
	0078010K	1.00	3.00		38.00	2.00			x
	0078011K	1.10	3.00		38.00	2.20			x
	0078012K	1.20	3.00		38.00	2.40			x
	0078013K	1.30	3.00		38.00	2.60			x
	0078014K	1.40	3.00		38.00	2.80			x
	0078015K	1.50	3.00		38.00	3.00			x
	0078016K	1.60	3.00		38.00	3.20			x
	0078017K	1.70	3.00		38.00	3.40			x
	0078018K	1.80	3.00		38.00	3.60			x
	0078019K	1.90	3.00		38.00	4.00			x
	0078020K	2.00	3.00		38.00	6.00			x
	0078025K	2.50	3.00		38.00	7.00			x

## End mill for cobalt-chrome/titanium

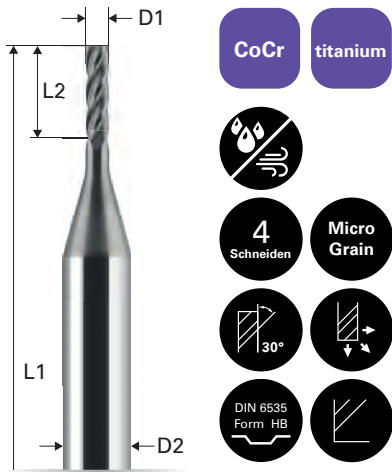

- CoCr titanium
- No sparks
- 4 Schneiden Micro Grain
- 30°
- Surface finish
- DIN 6535 Form HB Chamfered edge

**End mill type:** End mill, four flute, with Weldon surface, coated

**Features:** Sharp flutes, precision plane face machining, ideal for screw contact surfaces and/or contour machining

**Indications:** Bars, interface connections, contact surfaces

cobalt-chrome/  
titanium

6 mm shank

	Item no.	D1 (mm)	D2 (mm)	D3 (mm)	L1 (mm)	L2 (mm)	L3 (mm)	R (mm)	BS
	0078402	2.00	6.00		50.00	7.00			x
	00784025	2.50	6.00		50.00	8.00			x
	0078403	3.00	6.00		57.00	8.00			x
	00784035	3.50	6.00		57.00	10.00			x
	0078404	4.00	6.00		57.00	11.00			x





**End mill type:** Toric end mill with edge radius; double flute, coated

**Features:** Ideal as starter tool for screw channels  
**Indications:** Starter tool with all standard indications. Otherwise bars, individual abutments, screw-retained restorations, interface connections (internal/external), screw contact surfaces

cobalt-chrome/  
titanium

3 mm shank

	Item no.	D1 (mm)	D2 (mm)	D3 (mm)	L1 (mm)	L2 (mm)	L3 (mm)	R (mm)	BS
	0078010R	1.00	3.00	0.95	48.00	1.20	15.00	0.10	x
	0078015R	1.50	3.00	1.40	48.00	1.80	16.00	0.15	x
	0078018R	1.80	3.00	1.70	48.00	2.20	16.00	0.18	x
	0078020R	2.00	3.00	1.90	48.00	2.40	16.00	0.20	x
	0078025R	2.50	3.00	2.40	48.00	3.00	18.00	0.25	x

cobalt-chrome/  
titanium

6 mm shank

	Item no.	D1 (mm)	D2 (mm)	D3 (mm)	L1 (mm)	L2 (mm)	L3 (mm)	R (mm)	BS
	0078015G	1.50	6.00	1.40	50.00	2.50	8.00	0.10	x

## Toric end mill for cobalt-chrome/titanium

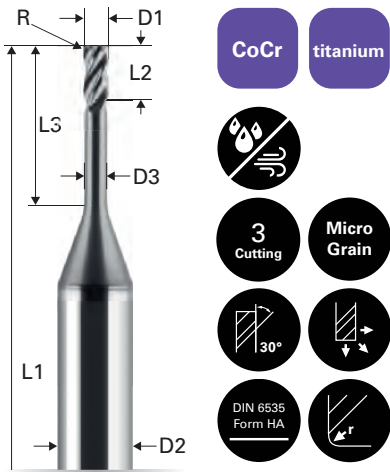



**End mill type:** Toric end mill with edge radius; triple flute, coated

**Features:** Roughing tool with high chip volume, ideal as starter tool for high material removal

**Indications:** Roughing or starter tool with all standard indications

cobalt-chrome/  
titanium

6 mm shank

	Item no.	D1 (mm)	D2 (mm)	D3 (mm)	L1 (mm)	L2 (mm)	L3 (mm)	R (mm)	BS
	0078011R	3.00	6.00	2.70	50.00	4.00	14.00	0.30	x
	0078011V	3.00	6.00	2.70	50.00	4.00	18.00	0.30	x

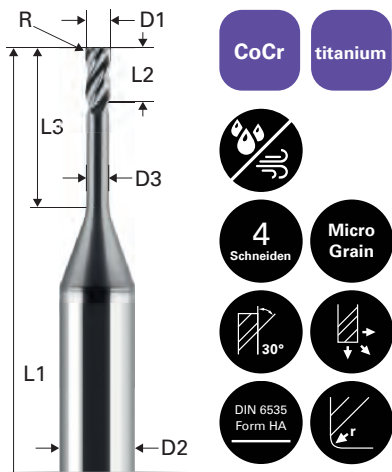





**End mill type:** Toric end mill with edge radius; four flute, coated

**Features:** Roughing tool with high chip volume, ideal as starter tool for high material removal

**Indications:** Roughing or starter tool with all standard indications

cobalt-chrome/  
titanium

6 mm shank

	Item no.	D1 (mm)	D2 (mm)	D3 (mm)	L1 (mm)	L2 (mm)	L3 (mm)	R (mm)	BS
	0078620	2.00	6.00	1.80	50.00	4.00	12.00	0.20	x
	0078620A	2.00	6.00	1.80	50.00	4.00	16.00	0.20	x
	0078623	3.00	6.00	2.70	50.00	4.00	14.00	0.30	x
	0078623A	3.00	6.00	2.70	50.00	4.00	18.00	0.30	x
	0078624	4.00	6.00	3.70	50.00	5.00	16.00	0.40	x

## Toric end mill for cobalt-chrome/titanium







**End mill type:** Toric end mill with double radius; four flute, coated

**Features:** Roughing tool with high chip volume, ideal as starter tool for high material removal

**Indications:** Roughing or starter tool with all standard indications

cobalt-chrome/  
titanium

6 mm shank

	Item no.	D1 (mm)	D2 (mm)	D3 (mm)	L1 (mm)	L2 (mm)	L3 (mm)	R (mm)	BS
	00786203	3.00	6.00	2.80	50.00	3.00	12.00	0.60	x
	00786203A	3.00	6.00	2.80	50.00	3.00	16.00	0.60	x
	00786204	4.00	6.00	3.80	50.00	4.00	14.00	0.80	x
	00786204A	4.00	6.00	3.80	50.00	4.00	16.00	0.80	x



**End mill type:** Drill, coated

**Features:** Extra-long useable drill lengths, enabling one-sided drill through without rotating work piece; this compensates for parallelism

**Indications:** All work that requires precision drilling



cobalt-chrome/  
titanium

3 mm shank

	Item no.	D1 (mm)	D2 (mm)	D3 (mm)	L1 (mm)	L2 (mm)	L3 (mm)	R (mm)	BS
	0078708	0.80	3.00		48.00	7.00			x
	0078709	0.90	3.00		48.00	9.00			x
	0078710	1.00	3.00		48.00	11.00			x
	0078711	1.10	3.00		48.00	11.00			x
	0078712	1.20	3.00		48.00	13.00			x
	00787125	1.25	3.00		48.00	13.00			x
	0078713	1.30	3.00		48.00	13.00			x
	0078714	1.40	3.00		48.00	15.00			x
	0078715	1.50	3.00		48.00	16.00			x
	0078716	1.60	3.00		48.00	16.00			x
	0078717	1.70	3.00		48.00	16.00			x
	0078718	1.80	3.00		48.00	17.00			x
	0078719	1.90	3.00		48.00	17.00			x
	0078720	2.00	3.00		48.00	20.00			x
	0078722	2.25	3.00		48.00	20.00			x

cobalt-chrome/  
titanium

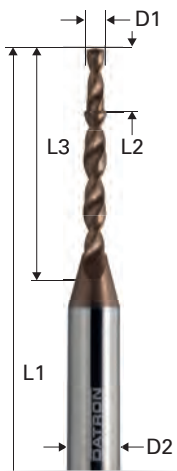

3 mm shank

	Item no.	D1 (mm)	D2 (mm)	D3 (mm)	L1 (mm)	L2 (mm)	L3 (mm)	R (mm)	BS
	0078725	2.50	3.00		48.00	20.00			x
	0078727	2.75	3.00		48.00	20.00			x
	0078730	3.00	3.00		48.00	20.00			x



cobalt-chrome/  
titanium

6 mm shank, step drill for CAMLOG, coated

	Item no.	D1 (mm)	D2 (mm)	D3 (mm)	L1 (mm)	L2 (mm)	L3 (mm)	R (mm)	BS
	0078731	1.60/ 2.20	6.00	2.20	50.00	6.35	12.00		x
	0078732	2.00/ 2.60	6.00	2.60	50.00	6.35	12.00		x

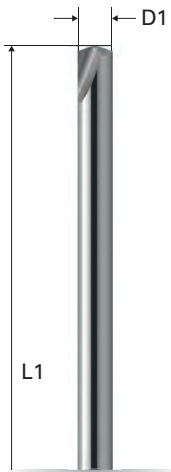

NEM

2 Schneiden

Micro Grain

130°

↓

DIN 6535 Form HA

140°

**End mill type:** Centre drill, uncoated

**Features:** Starter centre tool for drilling process, the drill is prevented from slipping

**Indications:** All work that requires precision drilling

We also recommend:



PMMA Wax

ZrO<sub>2</sub>

Komposite

non-precious metal

3 mm shank

	Item no.	D1 (mm)	D2 (mm)	D3 (mm)	L1 (mm)	L2 (mm)	L3 (mm)	R (mm)	BS
	0078701	1.00	3.00		48.00				
	0078703	3.00	3.00		48.00				



## High-precision tools ( $\pm 5 \mu$ ) for cobalt-chrome/titanium

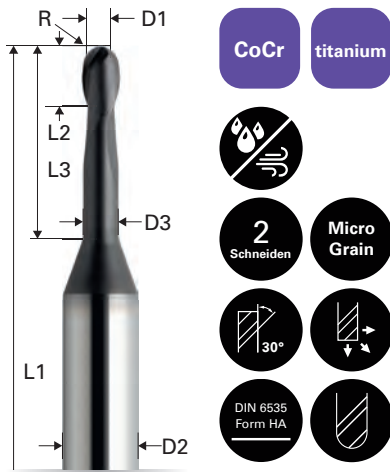



**End mill type:** Ball nose end mill, double flute, high-precision tools  $\pm 5 \mu$ , coated

**Features:** Shank diameter with accuracy of  $\pm 5 \mu$ ; high coating hardness specially designed for hard materials that are difficult to mill

**Indications:** Copings, crowns, bridges, bars, individual abutments, screw-retained restorations, interface connections

cobalt-chrome/  
titanium

6 mm shank

	Item no.	D1 (mm)	D2 (mm)	D3 (mm)	L1 (mm)	L2 (mm)	L3 (mm)	R (mm)	BS
	0078836T	1.00	6.00	0.95	50.00	3.00	8.00	0.50	x
	0078839T	1.50	6.00	1.45	50.00	4.00	12.00	0.75	x



CoCr titanium



2  
Schneiden



DIN 6535  
Form HA



**End mill type:** End mill, double flute, high-precision tools  $\pm 5\mu$ , coated

**Features:** Shank diameter with an accuracy of  $\pm 5\mu$ ; very sharp flutes, precision plane face machining, ideal for screw contact surfaces and/or contour machining

**Indications:** Bars, individual abutments, screw-retained restorations, interface connections, screw contact surfaces

cobalt-chrome/  
titanium

3 mm shank

	Item no.	D1 (mm)	D2 (mm)	D3 (mm)	L1 (mm)	L2 (mm)	L3 (mm)	R (mm)	BS
	0078837T	2.00	3.00		38.00	6.00			x

cobalt-chrome/  
titanium

6 mm shank

	Item no.	D1 (mm)	D2 (mm)	D3 (mm)	L1 (mm)	L2 (mm)	L3 (mm)	R (mm)	BS
	0078835T	1.50	6.00	1.40	50.00	2.50	8.00		x

## High-precision tools ( $\pm 5 \mu$ ) for cobalt-chrome/titanium

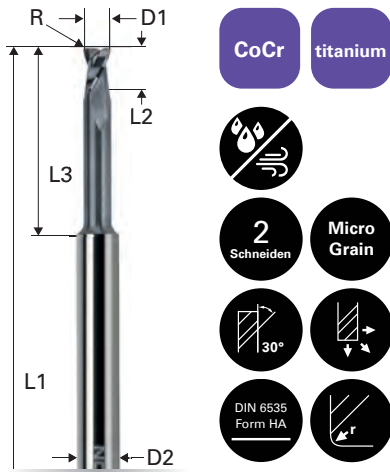

**End mill type:** Toric end mill, double flute, high-precision tools  $\pm 5 \mu$ , coated

**Features:** Shank diameter with accuracy of  $\pm 5 \mu$ ; ideal as starter tool for screw channels

**Indications:** Bars, individual abutments, screw-retained restorations, interface connections, screw contact surfaces

cobalt-chrome/  
titanium

3 mm shank

Item no.	D1 (mm)	D2 (mm)	D3 (mm)	L1 (mm)	L2 (mm)	L3 (mm)	R (mm)	BS
0078838T	2.00	3.00	1.90	48.00	2.40	16.00	0.20	x



cobalt-chrome/  
titanium

6 mm shank

Item no.	D1 (mm)	D2 (mm)	D3 (mm)	L1 (mm)	L2 (mm)	L3 (mm)	R (mm)	BS
0078010T	1.50	6.00	1.40	50.00	2.50	8.00	0.10	x



## Seat milling cutter for hybrid machining for cobalt-chrome/titanium

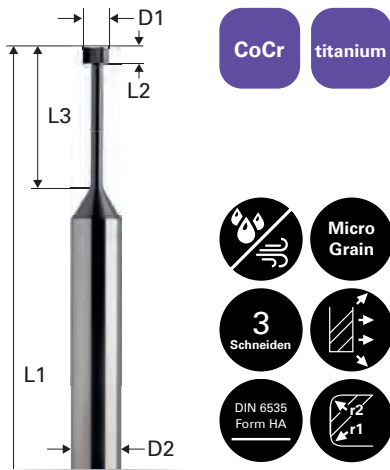





**End mill type:** Seat milling cutter, three flute, coated

**Features:** Machining the screw seat area through the screw channel, flat and conical areas of the screw contact surface, angled screw channels

**Indications:** Bars, individual abutments, screw-retained restorations, screw contact surfaces

cobalt-chrome/  
titanium

3 mm shank

	Item no.	D1 (mm)	D2 (mm)	D3 (mm)	L1 (mm)	L2 (mm)	L3 (mm)	R1 (mm)	R2 (mm)	BS
	0078807E	1.90	3.00	0.80	40.00	1.10	8.60	0.05	0.05	x
	0078807F	1.70	3.00	0.70	40.00	1.00	8.00	0.05	0.05	x
	0078807G	1.50	3.00	0.60	40.00	0.90	7.40	0.05	0.05	x
	0078807H	1.30	3.00	0.50	40.00	0.80	6.80	0.05	0.05	x



## DATRON milling tools for zirconia

- Ball nose end mill, uncoated
- Ball nose end mill, diamond-coated
- Ball nose end mill, high-end coated
- Spherical (lollipop), diamond-coated
- End mill, uncoated



**Ball nose end mill**  
from page 35



**Spherical**  
from page 39



**End mill**  
from page 40

## Ball nose end mill for zirconia

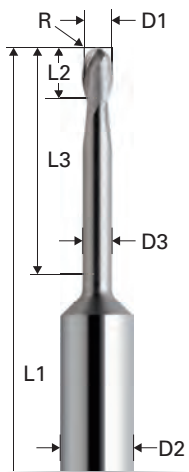

ZrO<sub>2</sub>

2  
Schneiden

Micro  
Grain

30°

30°

DIN 6535  
Form HA

30°

Luft-  
kühlung

Trocken-  
bearbeitung

**End mill type:**

Ball nose end mill, double flute, uncoated

**Features:**

Very sharp flutes, because not treated

**Indications:**

Copings, crowns (anatomic, anatomically reduced), bridges, bars, individual abutments, screw-retained restorations, 3D free-form surfaces

zirconia

3 mm shank, short neck

	Item no.	D1 (mm)	D2 (mm)	D3 (mm)	L1 (mm)	L2 (mm)	L3 (mm)	R (mm)	BS
	00784003	0.30	3.00		40.00	0.50		0.15	
	00784005	0.50	3.00		39.00	0.80		0.25	
	00784007	0.70	3.00		39.00	2.10		0.35	









zirconia

3 mm shank, short neck

	Item no.	D1 (mm)	D2 (mm)	D3 (mm)	L1 (mm)	L2 (mm)	L3 (mm)	R (mm)	BS
	00782004	0.40	3.00	0.35	39.00	0.60	2.00	0.20	
	00782005	0.50	3.00	0.45	39.00	0.75	4.00	0.25	
	00782005L	0.50	3.00	0.45	39.00	0.75	10.00	0.25	
	00782006	0.60	3.00	0.55	39.00	0.90	4.00	0.30	
	00782008	0.80	3.00	0.75	39.00	1.20	6.00	0.40	
	00782010	1.00	3.00	0.95	39.00	1.50	6.00	0.50	
	00782011	1.00	3.00	0.95	39.00	1.50	9.00	0.50	
	00782012	1.20	3.00	1.15	39.00	1.80	9.00	0.60	
	00782015	1.50	3.00	1.45	39.00	2.20	9.00	0.75	
	00782020	2.00	3.00	1.95	39.00	3.00	12.00	1.00	







zirconia

3 mm shank, long neck

	Item no.	D1 (mm)	D2 (mm)	D3 (mm)	L1 (mm)	L2 (mm)	L3 (mm)	R (mm)	BS
	00782106	0.60	3.00	0.55	48.00	2.50	10.00	0.30	
	00782108	0.80	3.00	0.75	48.00	3.00	12.00	0.40	
	0078211K	1.00	3.00	0.95	48.00	4.00	14.00	0.50	
	00782110	1.00	3.00	0.95	48.00	4.00	18.00	0.50	
	00782115	1.50	3.00	1.45	48.00	4.00	18.00	0.75	
	00782120	2.00	3.00	1.95	48.00	4.50	22.00	1.00	
	00782125	2.50	3.00	2.40	48.00	6.00	20.00	1.25	
	00782130	3.00	3.00	2.90	48.00	6.00	22.00	1.50	

zirconia

6 mm shank, long neck

	Item no.	D1 (mm)	D2 (mm)	D3 (mm)	L1 (mm)	L2 (mm)	L3 (mm)	R (mm)	BS
	00782706	0.60	6.00	0.55	50.00	2.50	10.00	0.30	
	00782708	0.80	6.00	0.75	50.00	3.00	12.00	0.40	
	00782710	1.00	6.00	0.95	50.00	4.00	18.00	0.50	
	00782715	1.50	6.00	1.45	50.00	4.00	18.00	0.75	
	00782720	2.00	6.00	1.95	50.00	4.50	22.00	1.00	
	00782725	2.50	6.00	2.40	50.00	5.00	25.00	1.25	
	00782730	3.00	6.00	2.80	50.00	6.00	25.00	1.50	



## Ball nose end mill for zirconia

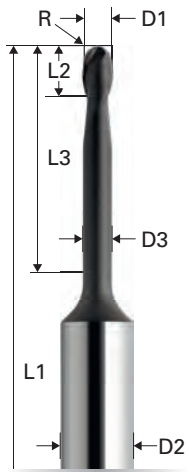

**ZrO<sub>2</sub>**

**2 Schneiden**   **Micro Grain**

**30°**   **30°**

**DIN 6535 Form HA**   **30°**

**Luftkühlung**   **Trockenbearbeitung**

**End mill type:** Ball nose end mill, double flute, coated

**Features:** Long tool life with diamond coating  
**Indications:** Copings, crowns (anatomic, anatomically reduced), bridges, bars, individual abutments, screw-retained restorations, 3D free-form surfaces

zirconia

3 mm shank, long neck

	Item no.	D1 (mm)	D2 (mm)	D3 (mm)	L1 (mm)	L2 (mm)	L3 (mm)	R (mm)	BS
	00786603	0.30	3.00	0.28	48.00	0.60	2.50	0.15	x
	00782206	0.60	3.00	0.55	48.00	2.50	10.00	0.30	x
	00782208	0.80	3.00	0.75	48.00	3.00	12.00	0.40	x
	00782210	1.00	3.00	0.95	48.00	4.00	16.00	0.50	x
	00782215	1.50	3.00	1.45	48.00	4.00	18.00	0.75	x
	00782220	2.00	3.00	1.95	48.00	4.50	20.00	1.00	x
	00782225	2.50	3.00	2.40	48.00	4.50	22.00	1.25	x
	00782230	3.00	3.00	2.90	48.00	6.00	25.00	1.50	x





zirconia

3 mm shank, Xtra long neck

	Item no.	D1 (mm)	D2 (mm)	D3 (mm)	L1 (mm)	L2 (mm)	L3 (mm)	R (mm)	BS
	0078221L	1.00	3.00	0.95	48.00	4.00	18.00	0.50	x
	0078222L	2.00	3.00	1.95	48.00	4.50	25.00	1.00	x
	0078225L	2.50	3.00	2.40	48.00	4.50	25.00	1.25	x









zirconia

## 4 mm shank, long neck

	Item no.	D1 (mm)	D2 (mm)	D3 (mm)	L1 (mm)	L2 (mm)	L3 (mm)	R (mm)	BS
	00783203	0.30	4.00	0.28	48.00	0.60	3.00	0.15	
	00783206	0.60	4.00	0.55	48.00	2.50	10.00	0.30	x
	00783210	1.00	4.00	0.95	48.00	4.00	18.00	0.50	x
	00783220	2.00	4.00	1.95	48.00	4.50	20.00	1.00	x
	00783225	2.50	4.00	2.40	48.00	5.00	22.00	1.25	x



zirconia

## 6 mm shank, long neck

	Item no.	D1 (mm)	D2 (mm)	D3 (mm)	L1 (mm)	L2 (mm)	L3 (mm)	R (mm)	BS
	00786703	0.30	6.00	0.28	50.00	0.60	2.50	0.15	x
	00782806	0.60	6.00	0.55	50.00	2.50	10.00	0.30	x
	00782808	0.80	6.00	0.75	50.00	3.00	12.00	0.40	x
	00782810	1.00	6.00	0.95	50.00	4.00	16.00	0.50	x
	00782811	1.00	6.00	0.95	50.00	4.00	25.00	0.50	x
	00782815	1.50	6.00	1.45	50.00	4.00	18.00	0.75	x
	00782820	2.00	6.00	1.95	50.00	4.50	20.00	1.00	x
	00782825	2.50	6.00	2.40	50.00	4.50	22.00	1.25	x
	00782830	3.00	6.00	2.80	50.00	6.00	25.00	1.50	x

zirconia

## 6 mm shank, Xtra long neck

	Item no.	D1 (mm)	D2 (mm)	D3 (mm)	L1 (mm)	L2 (mm)	L3 (mm)	R (mm)	BS
	0078281L	1.00	6.00	0.95	50.00	4.00	18.00	0.50	x
	0078282L	2.00	6.00	1.95	50.00	4.50	25.00	1.00	x
	0078285L	2.50	6.00	2.40	50.00	4.50	25.00	1.25	x

## Spherical (lollipop) for zirconia

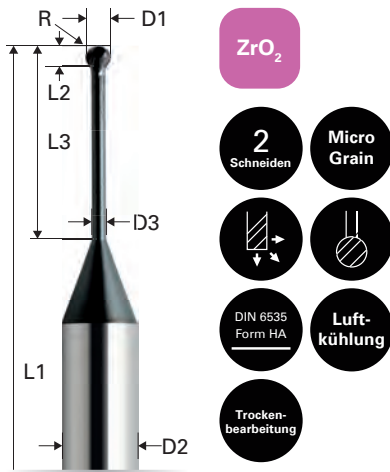

ZrO<sub>2</sub>

2  
Schneiden

Micro  
Grain



DIN 6535  
Form HA

Luft-  
kühlung

Trocken-  
bearbeitung

**End mill type:** Spherical (lollipop); double flute, coated

**Features:** Flexible machining options with undercuts without having to tilt the work piece

**Indications:** Copings, crowns (anatomic), undercut machining, outer contours, internal contours

zirconia

3 mm shank, long neck

Item no.	D1 (mm)	D2 (mm)	D3 (mm)	L1 (mm)	L2 (mm)	L3 (mm)	R (mm)	Ball (de- gree)	BS
00784310	2.00	3.00	1.10	48.00	1.84	14.00	1.00	270	x

zirconia

6 mm shank, long neck

Item no.	D1 (mm)	D2 (mm)	D3 (mm)	L1 (mm)	L2 (mm)	L3 (mm)	R (mm)	Ball (de- gree)	BS
00784610	2.00	6.00	1.10	50.00	1.84	14.00	1.00	270	x

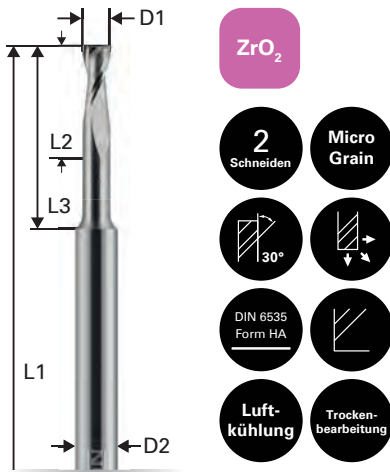

**End mill type:** End mill, double flute, uncoated

**Features:** Very sharp flutes, precision machining of flat surfaces, ideal for screw contact surfaces and/or contour machining

**Indications:** Bars, individual abutments, screw-retained restorations, interface connections (internal/external), screw contact surfaces

zirconia

3 mm shank, long neck

	Item no.	D1 (mm)	D2 (mm)	D3 (mm)	L1 (mm)	L2 (mm)	L3 (mm)	R (mm)	BS
	00781005	0.50	3.00	0.45	40.00	0.75	4.00		
	00781006	0.60	3.00	0.55	40.00	0.90	4.00		
	00781007	0.70	3.00	0.65	38.00	1.05	4.00		
	00781008	0.80	3.00	0.75	38.00	1.20	6.00		
	00781009	0.90	3.00	0.85	38.00	1.30	6.00		
	00781010	1.00	3.00	0.95	38.00	1.50	6.00		
	00781011	1.00	3.00	0.95	38.00	1.50	9.00		
	00781012	1.20	3.00	1.15	38.00	1.80	9.00		
	00781015	1.50	3.00	1.45	38.00	2.20	9.00		
	00781020	2.00	3.00	1.95	38.00	3.00	12.00		



# DATRON milling tools for PMMA/wax

- Ball nose end mill for PMMA/wax



**Ball nose end mill  
with one flute**  
page 43



**Ball nose end mill**  
page 44

**PMMA**

**wax**

## Ball nose end mill for PMMA/wax

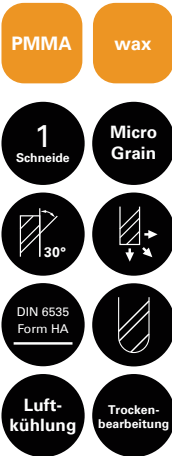
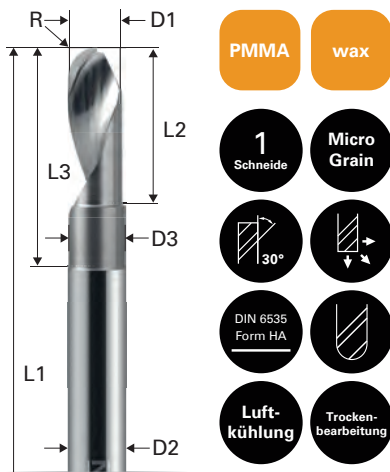

**End mill type:** Ball nose end mill, single flute, polished flutes, uncoated

**Features:** Polished, very sharp flutes, burr-free and clean machining without adhesions to the flute edge and in the chip channel

**Indications:** Copings, crowns (anatomic, anatomically reduced), surface machining, short-term temporary dentures, 3D free-form surfaces

PMMA/  
wax

3 mm shank, long neck

	Item no.	D1 (mm)	D2 (mm)	D3 (mm)	L1 (mm)	L2 (mm)	L3 (mm)	R (mm)	BS
	0078181E	1.00	3.00	0.95	50.00	4.00	12.00	0.50	
	0078182E	2.00	3.00	1.95	50.00	6.00	20.00	1.00	
	0078183E	3.00	3.00	2.95	50.00	8.00	21.00	1.50	

PMMA/  
wax

6 mm shank, long neck

	Item no.	D1 (mm)	D2 (mm)	D3 (mm)	L1 (mm)	L2 (mm)	L3 (mm)	R (mm)	BS
	0078191E	1.00	6.00	0.90	50.00	4.00	12.00	0.50	
	0078191S	1.50	6.00	1.40	50.00	5.00	12.00	0.75	
	0078192E	2.00	6.00	1.80	50.00	6.00	20.00	1.00	
	0078192S	2.50	6.00	2.30	50.00	7.00	20.00	1.25	
	0078193E	3.00	6.00	2.80	50.00	8.00	21.00	1.50	
	0078194E	4.00	6.00	3.80	50.00	10.00	21.00	2.00	
	0078195E	5.00	6.00	4.80	50.00	12.00	22.00	2.50	
	0078196E	6.00	6.00	5.80	50.00	14.00	22.00	3.00	

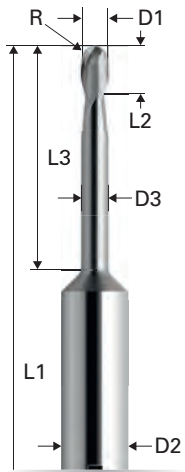

PMMA wax

2 Schneiden Micro Grain

30°

DIN 6535 Form HA

Luftkühlung Trockenbearbeitung

**End mill type:** Ball nose end mill, double flute, uncoated

**Features:** Burr-free and clean machining without adhesions to the flute edge and in the chip channel

**Indications:** Copings, crowns (anatomic, anatomically reduced), surface machining, short-term temporary dentures, 3D free-form surfaces

PMMA/wax











3 mm shank, long neck

	Item no.	D1 (mm)	D2 (mm)	D3 (mm)	L1 (mm)	L2 (mm)	L3 (mm)	R (mm)	BS
	00782406	0.60	3.00	0.55	48.00	2.50	10.00	0.30	
	00782408	0.80	3.00	0.75	48.00	3.50	12.00	0.40	
	00782410	1.00	3.00	0.95	48.00	4.00	16.00	0.50	
	00782415	1.50	3.00	1.45	48.00	4.50	18.00	0.75	
	00782420	2.00	3.00	1.95	48.00	5.50	20.00	1.00	
	00782425	2.50	3.00	2.40	48.00	6.00	25.00	1.25	







PMMA/  
wax

3 mm shank, short neck

	Item no.	D1 (mm)	D2 (mm)	D3 (mm)	L1 (mm)	L2 (mm)	L3 (mm)	R (mm)	BS
	00784204	0.40	3.00	0.35	39.00	0.60	2.00	0.20	
	00784205	0.50	3.00	0.45	39.00	0.75	4.00	0.25	
	00784205L	0.50	3.00	0.45	39.00	0.75	10.00	0.25	
	00784206	0.60	3.00	0.55	39.00	0.90	4.00	0.30	
	00784208	0.80	3.00	0.75	39.00	1.20	6.00	0.40	
	00784210	1.00	3.00	0.95	39.00	1.50	6.00	0.50	
	00784211	1.00	3.00	0.95	39.00	1.50	9.00	0.50	
	00784212	1.20	3.00	1.15	39.00	1.80	9.00	0.60	
	00784215	1.50	3.00	1.45	39.00	2.20	9.00	0.75	
	00784220	2.00	3.00	1.95	39.00	3.00	12.00	1.00	







PMMA/  
wax

4 mm shank, long neck

	Item no.	D1 (mm)	D2 (mm)	D3 (mm)	L1 (mm)	L2 (mm)	L3 (mm)	R (mm)	BS
	00783406	0.60	4.00	0.55	48.00	2.50	10.00	0.30	
	00783410	1.00	4.00	0.95	48.00	4.00	18.00	0.50	
	00783420	2.00	4.00	1.95	48.00	4.50	20.00	1.00	
	00783425	2.50	4.00	2.40	48.00	5.00	22.00	1.25	

PMMA/  
wax

6 mm shank, long neck

	Item no.	D1 (mm)	D2 (mm)	D3 (mm)	L1 (mm)	L2 (mm)	L3 (mm)	R (mm)	BS
	00782906	0.60	6.00	0.55	50.00	2.50	10.00	0.30	
	00782908	0.80	6.00	0.75	50.00	3.00	12.00	0.40	
	00782910	1.00	6.00	0.95	50.00	4.00	16.00	0.50	
	00782915	1.50	6.00	1.45	50.00	4.00	18.00	0.75	
	00782920	2.00	6.00	1.95	50.00	4.50	20.00	1.00	
	00782925	2.50	6.00	2.40	50.00	5.00	25.00	1.25	
	00782930	3.00	6.00	2.90	50.00	6.00	25.00	1.50	



## DATRON milling tools for composites

- Ball nose end mill for composites



**Ball nose end mill**  
from page 49

**composites**

# Ball nose end mill for composites

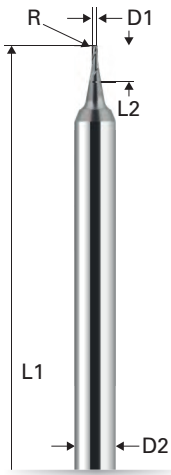





- composites
- 2 Schneiden
- Micro Grain
- 30°
- DIN 6535 Form HA
- Luftkühlung
- Trockenbearbeitung

**End mill type:** Micro ball nose, double flute, coated

**Features:** Stable design with short flutes  
**Indications:** Fissures, 3D free-form surfaces

composites

3 mm shank, short neck

	Item no.	D1 (mm)	D2 (mm)	D3 (mm)	L1 (mm)	L2 (mm)	L3 (mm)	R (mm)	BS
	00782504	0.40	3.00		39.00	1.20		0.20	x
	00782505	0.50	3.00		39.00	0.80		0.25	
	00782506	0.60	3.00		39.00	1.80		0.30	x
	00782508	0.80	3.00		38.00	2.40		0.40	x

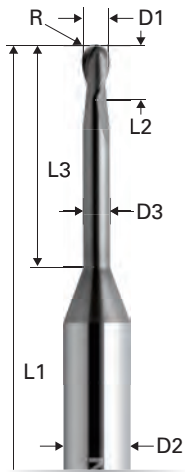

- composites
- 2 Schneiden
- Micro Grain
- 30°
- DIN 6535 Form HA
- Luftkühlung
- Trockenbearbeitung

**End mill type:** Ball nose end mill, double flute, coated

**Features:** Long tool life in highly abrasive media  
**Indications:** Copings, crowns (anatomic), bridges, bars, individual abutments, screw-retained restorations, short and long-term temporary dentures, 3D free-form surfaces

composites

3 mm shank, long neck

	Item no.	D1 (mm)	D2 (mm)	D3 (mm)	L1 (mm)	L2 (mm)	L3 (mm)	R (mm)	BS
	00782510	1.00	3.00	0.95	48.00	4.00	16.00	0.50	x
	00782515	1.50	3.00	1.45	48.00	4.50	18.00	0.75	x
	00782520	2.00	3.00	1.95	48.00	5.50	20.00	1.00	x
	00782525	2.50	3.00	2.40	48.00	6.00	22.00	1.25	x

composites

6 mm shank, long neck

	Item no.	D1 (mm)	D2 (mm)	D3 (mm)	L1 (mm)	L2 (mm)	L3 (mm)	R (mm)	BS
	00783008	0.80	6.00	0.75	50.00	3.50	12.00	0.40	x
	00783010	1.00	6.00	0.95	50.00	4.00	14.00	0.50	x
	00783015	1.50	6.00	1.45	50.00	4.50	16.00	0.75	x
	00783020	2.00	6.00	1.95	50.00	5.50	18.00	1.00	x
	00783025	2.50	6.00	2.40	50.00	4.50	20.00	1.25	x
	00783030	3.00	6.00	2.80	50.00	6.00	22.00	1.50	x

## Ball nose end mill for composites



composites

4  
Schneiden

Micro  
Grain

30°

DIN 6535  
Form HB

Luft-  
kühlung

Trocken-  
bearbeitung

### End mill type:

Ball nose end mill, four flutes, coated

### Features:

Welded surface, high material removal in highly abrasive media

### Indications:

Roughing or starter tool with all standard indications, 3D free-form surfaces

composites

6 mm shank, long neck

	Item no.	D1 (mm)	D2 (mm)	D3 (mm)	L1 (mm)	L2 (mm)	L3 (mm)	R (mm)	BS
	0078542	2.00	6.00		57.00	6.00		1.00	x
	0078543	3.00	6.00		57.00	8.00		1.50	x
	0078543A	3.00	6.00		57.00	20.00		1.50	x
	0078543B	3.00	6.00		50.00	20.00		1.50	x
	0078544	4.00	6.00		57.00	11.00		2.00	x
	0078544A	4.00	6.00		57.00	20.00		2.00	x









**PLACE YOUR ORDER NOW:**



**Order Hotline: +49 (0)6151-1419-111**

**Tool Consultancy/Competence Center Tools: +49 (0)6151-1419-480**