



DATRON
Smart Manufacturing Solutions



DATRON

HIGH-SPEED CNC MILLING MACHINES

Precision. Performance. For Aluminium and other Materials...

More than Just Mechanical Engineering

PUT YOUR TRUST IN DATRON'S ALL-ROUND EXPERTISE

We at DATRON see ourselves as your partners in successful production. We provide everything you need from a single source. Not only does DATRON offer you pioneering mechanical engineering that is as sound and reliable as you would expect from products made in Germany; we are also your constant companion, providing everything from technology consulting and guidance through the sales process to an outstanding maintenance and repair service, as well as training and advice on how to achieve energy- and cost-efficient production.

With a comprehensive range of accessories and our expert knowledge, we configure DATRON machines to suit your production requirements to optimum effect. You can choose from different machine sizes, a range of high-performance machining spindles and numerous other standard options. In addition, we also offer customised process support to suit your specific requirements.

You can choose individual services or a comprehensive service providing you with a turnkey solution. Choose your DATRON machine with the appropriate clamping system, the optimum cooling spray system, rotary axes, sensors, automation, CAD/CAM software packages and much more besides.







Benefit from:

- + Customised solutions
- + Personal application consulting
- + Integrated clamping technology
- + Customised automation solutions
- + On-site installation
- + Training at the DATRON Tech Academy or at your premises

Benefit from our experts' in-depth knowledge in many fields of production engineering. We will be happy to advise you on optimising all stages of the production chain:

from CAD design to CAM data generation, clamping, measurement, tooling and cooling technology and the entire material flow.

Often it is the coordination and optimisation of the entire process chain that delivers the critical benefits in terms of costs and quality.

-  TECHNOLOGY CONSULTING
-  PROCESS SUPPORT
-  MACHINE PERFORMANCE DEMO
-  PROGRAM OPTIMISATION
-  CUSTOMER SERVICE
-  TRAINING

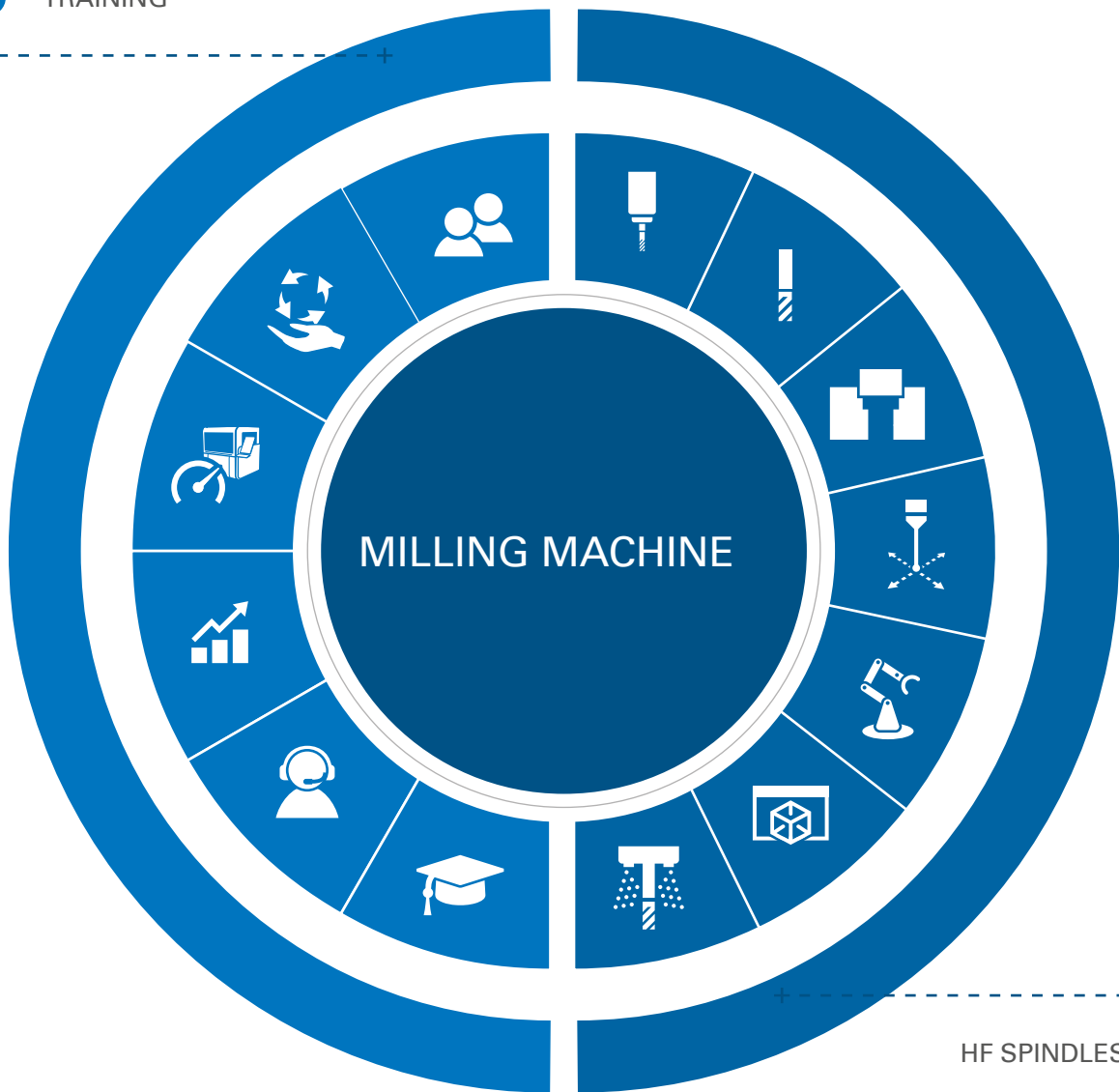

- HF SPINDLES 
- MILLINGTOOLS 
- CLAMPINGTECHNOLOGY 
- MEASUREMENTTECHNOLOGY 
- AUTOMATION 
- CAM SOFTWARE 
- COOLANTS/LUBRICANTS 

PROCESS
RELIABLE

PROCESS
RELIABLE

PRECISION
PRECISION

TOP
QUALITY

TOP
QUALITY

INDUSTRY
4.0

INDUSTRY
4.0

EFFICIENT
EFFICIENT

ADDED
VALUE

ADDED
VALUE

INNOVATIVE
INNOVATIVE

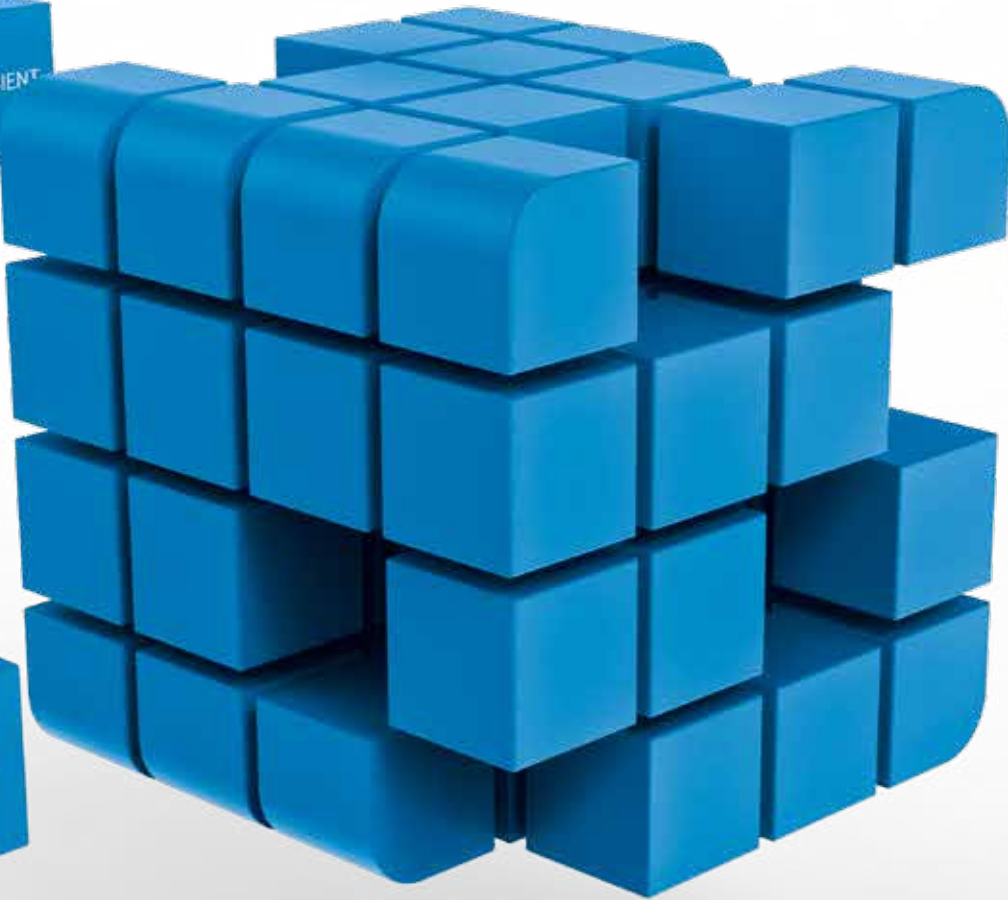

BRAND PROMISE



More than Just Mechanical Engineering

Not only do we offer groundbreaking mechanical engineering; we also accompany you throughout the entire workflow involved in milling: providing everything from technology consulting and guidance through the sales process to an optimised maintenance and repair service.

Optimum Price-Performance Ratio

The outstanding price-performance ratio of our high-performance DATRON milling technologies means you benefit from extremely high and lasting cost efficiency – even for small quantities.

Quality and Precision

Our industrial milling machines offer a combination of small milling tools and high speeds that deliver high-precision machining results and a high-quality surface finish that requires no further work.

Economical and Efficient

Many industrial enterprises are increasingly focusing on energy-efficient production and the efficient use of resources. In addition to providing our customers with cost-effective production solutions, we adopt a sustainable strategic approach when developing our energy-efficient HSC milling machines.

Innovative Technologies

The fourth industrial revolution is a key driver behind the launch of new generations of machines. Our strategic priority is to provide you with lasting industrial solutions for cost-efficient production based on our innovative technologies.

Made in Germany

We develop and manufacture all our products in Germany, and combined with our many years of experience in mechanical engineering, this allows us to maintain such high quality standards. In order to be able to deliver the same high quality to customers worldwide, we maintain a constant dialogue with our international trading partners. Our aim is to turn enthusiastic users into genuine fans.

Everything from a Single Source

You need only one specialist: DATRON. As mechanical engineering experts with our own tool brand and high-quality accessory products, we can provide you with the entire process chain required for high-quality milling results – as a turnkey solution from a single source.



DATRON TECHNOLOGIES

Ergonomic Design

The ergonomically designed access to the working area at the front of the DATRON milling machine allows workpieces to be set up quickly and easily. In addition, everything the machine operator needs is clearly laid out, making it easy to focus exclusively on the task.

High-Frequency Spindles

Our HF spindles permit the use of high-speed milling tools that are smaller than 0.1 mm but also deliver high cutting performance with cutter heads of up to 20 mm.

Cooling Lubrication System

Optimised resource- and cost-efficient processes thanks to a minimum-quantity cooling lubrication system and associated higher tool lives.

Module Clamping Technology

Regardless of whether a pneumatic or vacuum clamping system is used, DATRON's systems are notable for their great flexibility, ease of use and short changeover times.

Automation

Are you planning to further increase your production output through automation? We will be happy to provide advice and assistance.

Tool Technology

Our high-speed milling tools are specifically designed for high speeds of up to 60,000 rpm and to help you realise the full potential of your industrial milling machine.

XYZ Sensor plus Camera

The revolutionary combination of swipe technology, a camera and a 3D measuring probe helps the user set up the workpiece and the point of origin correctly.

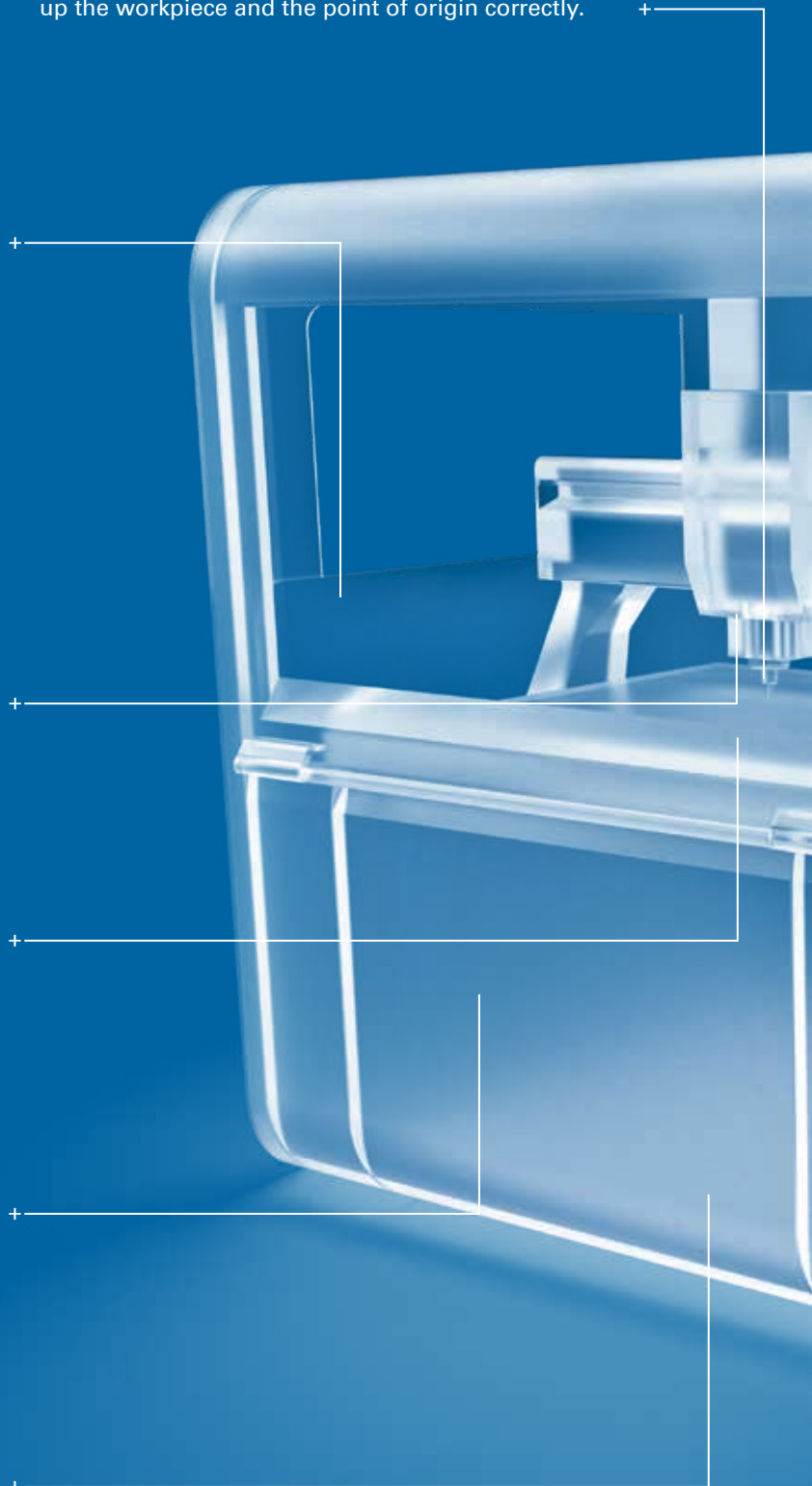



Three Axes (plus two Optional Axes)

Our high-speed technologies are equipped with three axes as standard and can be upgraded with an optional rotary axis for the high-precision machining of multiple sides of precision parts.



Tool Magazines and Length Sensor

The automatic tool changers for DATRON machining systems increase the flexibility and efficiency of the milling machine.

DATRON next

The revolutionary control software brings smartphone-type ease of use and simplicity to machine tools. DATRON next is the ideal solution for cost-efficient production given different machining requirements, components and batch sizes.

Highly Dynamic System

Designed mechanically for acceleration and rigidity and with an optimised control system, DATRON machine systems are highly dynamic and thus deliver an excellent surface finish with HSC machining.

Footprint

DATRON machine systems offer a large machining area yet have a small footprint and thus save a lot of space.

Precision

The unique combination of effective, high-speed DATRON technologies delivers the precision you require.

DATRON

INDUSTRIES AND APPLICATIONS

High-Precision, Contour-Accurate, High-Speed Milling
with an Outstanding Surface Finish

Industries

- + Electronics industry
- + Medical technology
- + Toolmaking and mouldmaking
- + Automotive industry
- + Prototype construction
- + Aerospace industry
- + Watchmaking and jewellery industry
- + Advertising industry
- + etc.



Materials

- + Aluminium
- + Non-ferrous metals
- + Steel (alloys)
- + Plastics
- + Composite materials (GRP, CRP, etc.)
- + Graphite
- + etc.

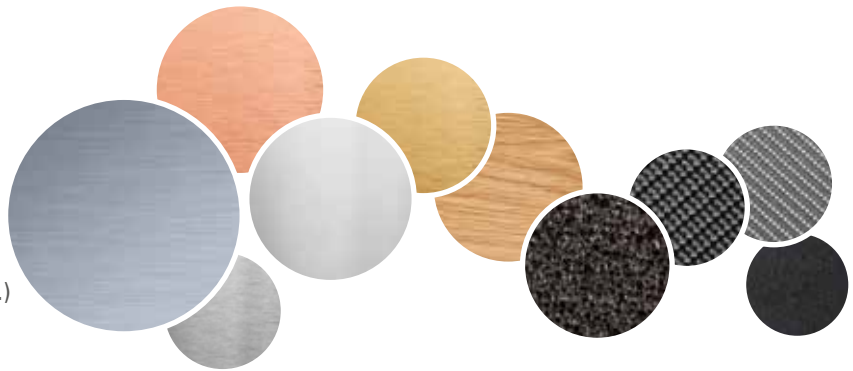

Applications

- + Front panels
- + Housing
- + 3D engraving and stamps
- + Electrode manufacture
- + Prototypes
- + Technical components
- + 5-axis machining
- + etc.



External



Perfect surface finish:
Contour-accurate HSC milling
without facets

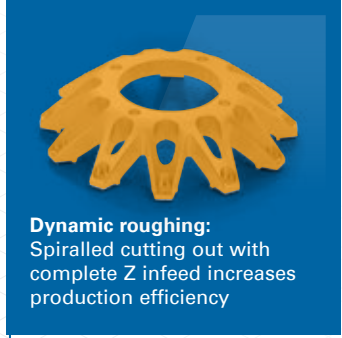

Dynamic roughing:
Spiralled cutting out with
complete Z infeed increases
production efficiency



Burr-free machining:
Edges require no further work

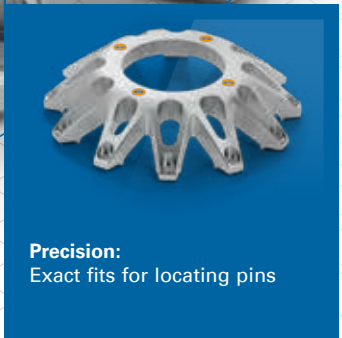
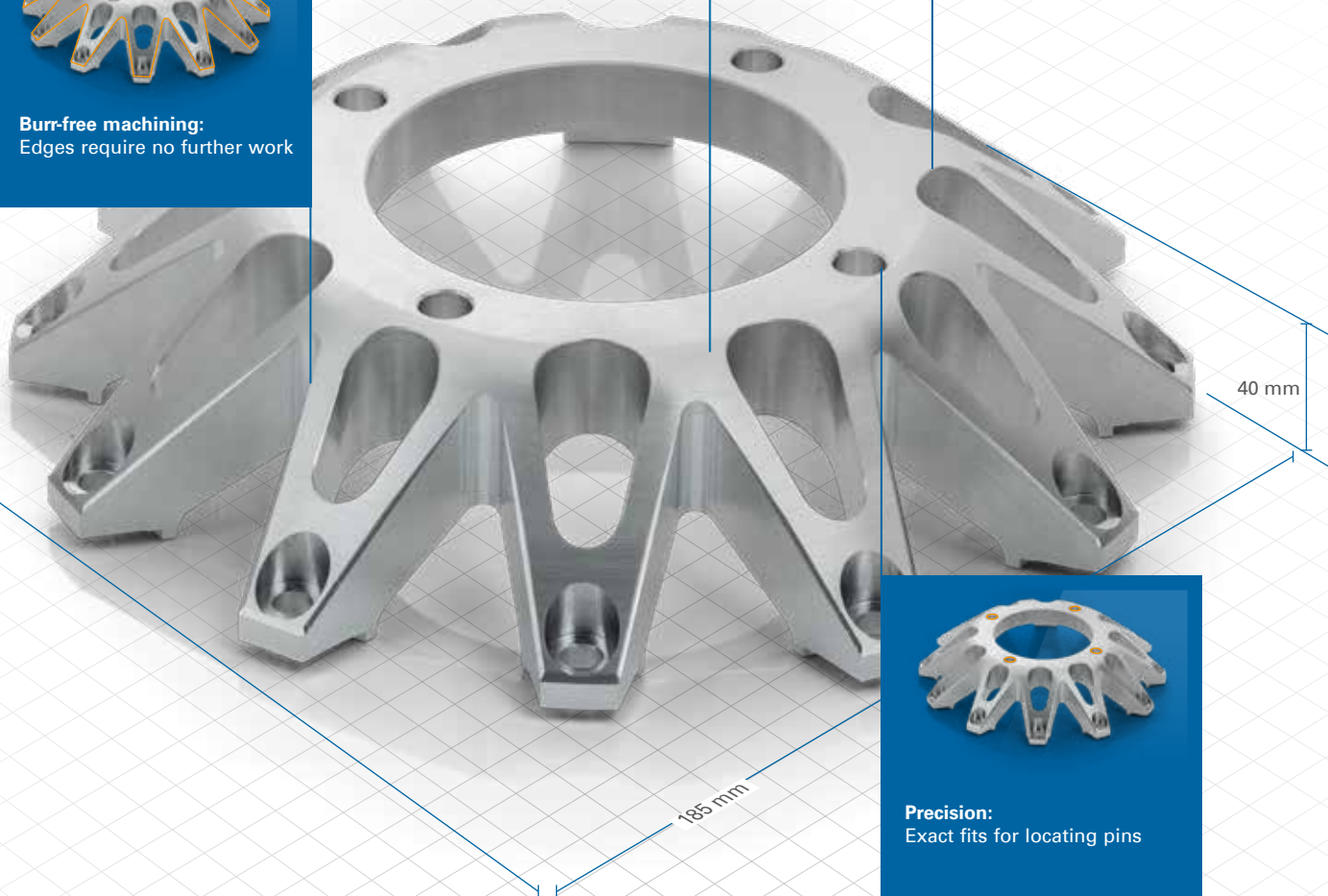

Precision:
Exact fits for locating pins

Total machining time with
DATRON M8Cube:
Internal: 40 minutes
External: 20 minutes



Internal



Use QR code for more information



reddot award 2016
winner interface design



DATRON next

MAKES MILLING AS EASY AS 3D PRINTING



10
11

At a Glance

- + Tile design with self-explanatory icons
- + Realistic 3D graphics
- + Current status of the machining operation also visible from a distance on the status screen

Ease of Use

- + Touchscreen as intuitive as a smartphone
- + Camera-assisted setup by means of swiping
- + App-based functions

Rapid Implementation of Ideas

- + Quick, easy process
- + A finished workpiece in four steps
- + Compatible with leading CAM vendors

DATRON next

FOUR STEPS TO THE FINISHED PART



The DATRON next CAM wizard is the ultimate in user friendliness. It helps you with all the processes involved in preparation for milling. In just four steps the CAM wizard takes you through the program and tool managers, helps you set up the workpiece and guides you through the workpiece simulation.

1 Select and Load



The DATRON next program manager allows you to load the milling program output by your CAM system via a network connection or USB device.

The DATRON next program manager calculates and displays each component for you. In this way you can select and load your projects quickly.

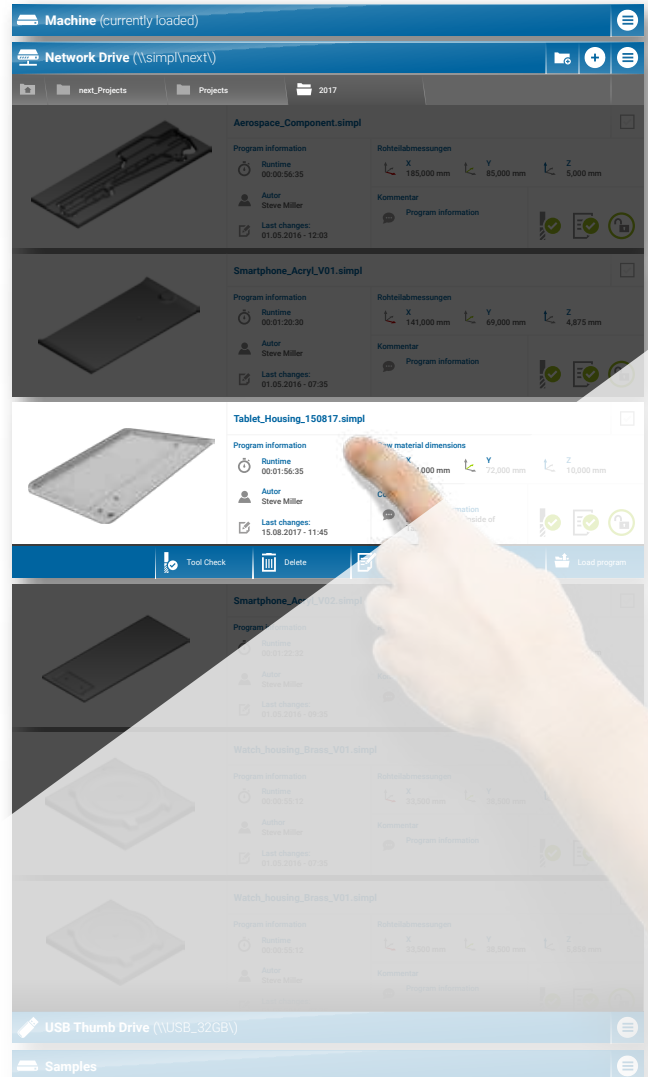

2 Set up Tools Quickly



The DATRON next tool manager puts you in full control of your tools. It gives you a quick but detailed overview of the type, diameter, cutter length and location.

A DATRON next filter function enables you to find the tool you are looking for within seconds. All DATRON tools and their parameters are stored in the tool manager. The time-consuming process of entering milling tool data manually is thus eliminated.



Automatic Checking

The tool check covers all the tools required by the CAM system. It compares them with the tools in the tool magazine.

You thus get a quick overview of which tools are available and which ones are still required. If necessary, the tool check also suggests alternatives.

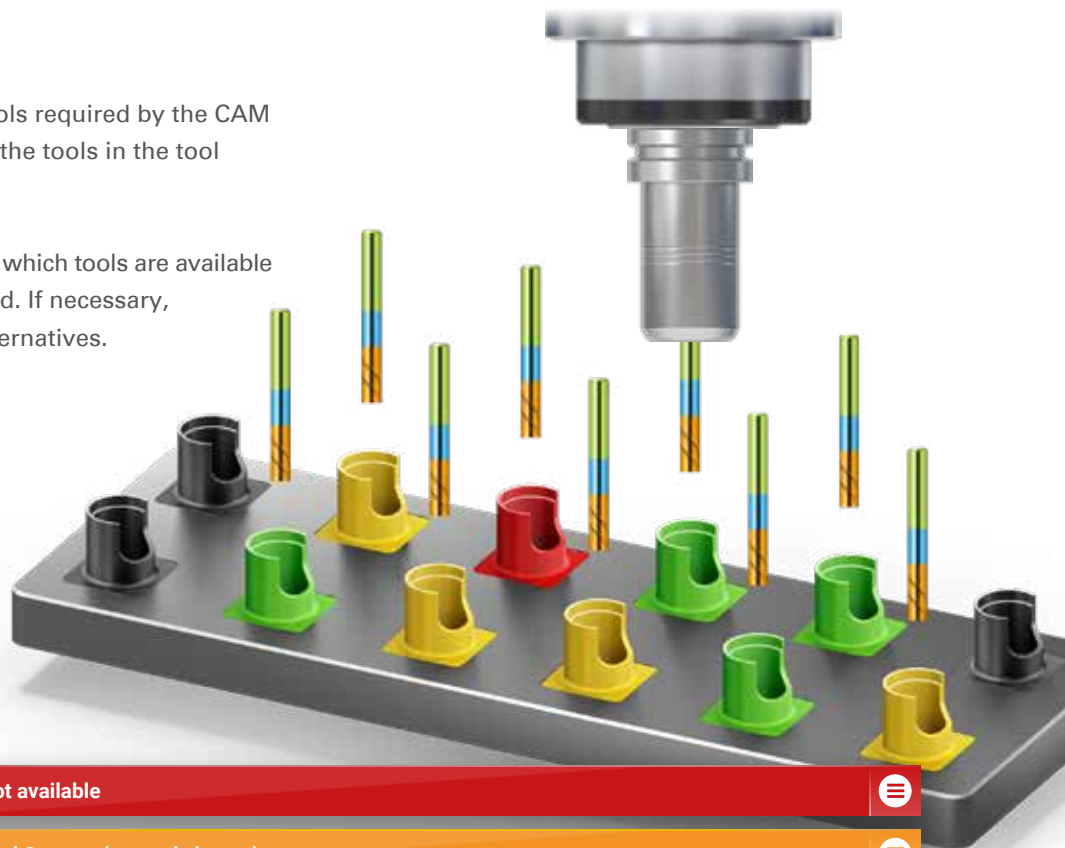

Not available

Tool Storage (manual change)

Tool Magazine

156

Ø 6.000 mm

Single Flute End Mill

Description	Supplier DATRON AG	Article number 0068960L
Comments		

Flute			Toric Cut		Shank		Length	
Ø	mm	Z	Ø	mm	Ø	mm	mm	
6 mm	20 mm	1 mm	6 mm	20 mm	8 mm	0 mm	60 mm	

3 Setup in Seconds with Camera and Swiping

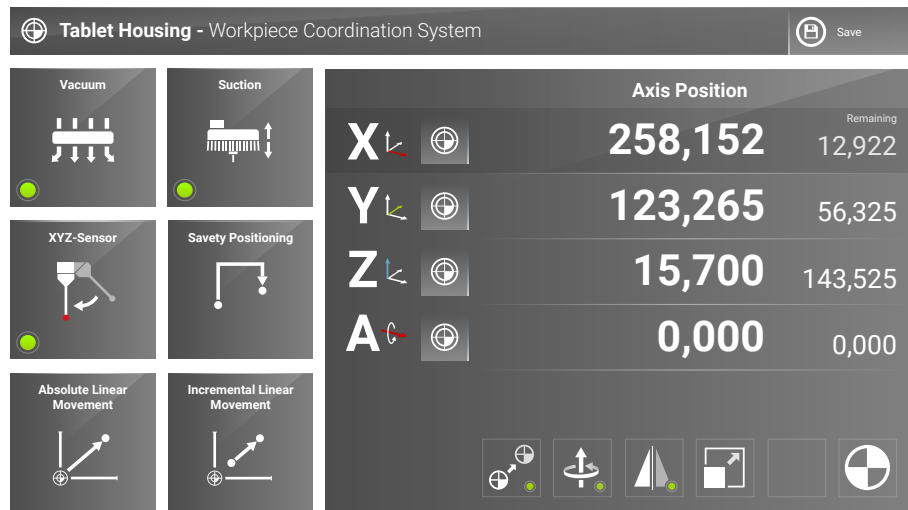

Revolutionary Workpiece Setup: Simplicity Itself

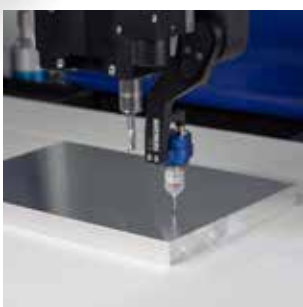

Correct workpiece setup – in other words, specifying its origin for the purpose of orientation in the work area – is one of the prerequisites for flawless machining.

DATRON next actively assists you with setup by means of the revolutionary combination of swiping, a camera and a 3D measuring probe (XYZ sensor). Even without experience with milling tools you will be able to set up your workpiece perfectly.

In addition, there are typical measuring cycles available to you that you can use with the help of intuitive graphics.

4 3D Milling Simulation



14
15

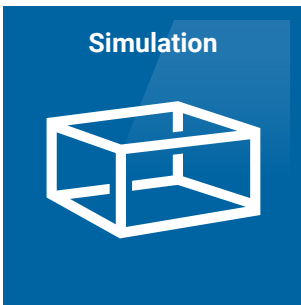

The DATRON next simulation calculates the milling paths, taking into account the tools selected in the machine. The workpiece is then displayed in 3D. You can thus view the entire machining process as a simulation and check in advance whether you are going to get your desired milling outcome. You can zoom, rotate and move the virtual workpiece as you like with your fingers.



Positioning Feed		Axis position		Remaining path
	3500 mm/min	X ↓	10,224	10,202
	5000 mm/min	Y ↓	-11,865	-15,775
		Z ↓	-3,250	2,256
		A ↓	0,000	0,000



Roughing	
Roughing	8 mm/min
Finishing	10 mm/min
Plunging	8 mm/min
Ramp	8 mm/min
Approach	8 mm/min

#213 Single Flute End Mill	
Description The patented balanced single flute end mill – an exclusive DATRON product. Powerful, economical and highly efficient.	
Comment	
Article number	Supplier
0068088E	DATRON AG
Flute	∅ 8 mm



Status Screen: Everything under Control

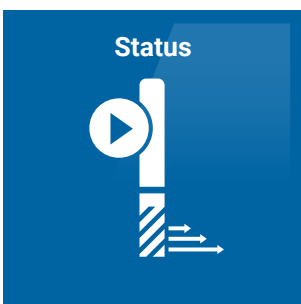

The status screen shows you all the relevant information at a glance. The progress of the program, the time remaining and the machine status are also visible from a distance.

DATRON next

ERGONOMIC DESIGN



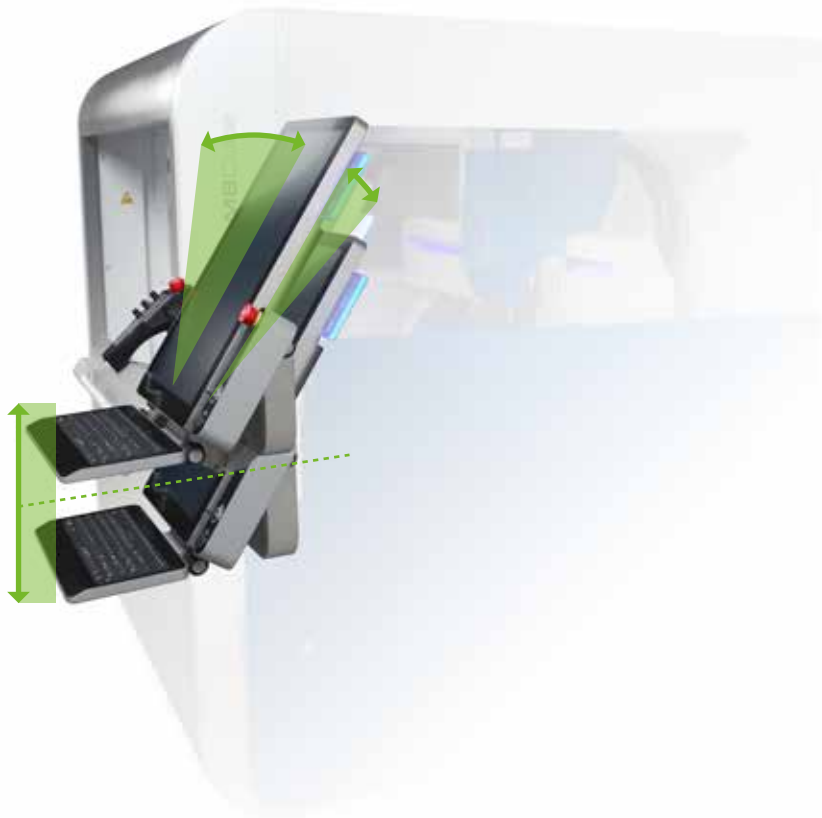

For years now we have been working continually to improve the working conditions of machine operators. We aim to create a positive working atmosphere and ensure that the operator is subjected to as little physical strain as possible.

In order to make our DATRON high-speed milling machines easy for every user to work with, the DATRON next terminal offers numerous valuable features:

- + A machine status signal light that can be seen easily from a distance
- + Continuously and easily adjustable operating terminal height.
- + Continuously swivellable display (anti-glare matt glass), allowing it to cope with even the most unfavourable light conditions
- + Swivellable or foldaway keyboard with ergonomically designed palm rest
- + Control elements, USB connector, emergency stop switch, key switch and hand-held control unit constantly at user-specific height



DATRON

MACHINE OVERVIEW

neo

M8Cube

ML Cube/ML Cube LS

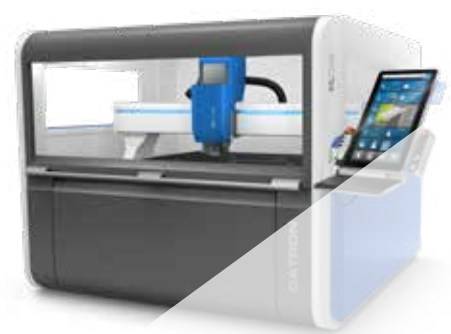

**& ERGONOMIC
& DYNAMIC**

**& PRODUCTIVE
& VERSATILE**

**& LARGE-FORMAT
& EFFICIENT**

Axis	3+1	3+2	3+1
Traverse path (XxY)*	520 mm x 420 mm	1,020 mm x 830 mm	1,520 mm x 1,150 mm
Portal passage	175 mm	200 mm	200 mm
Spindles	2.0 kW HF spindle up to 40,000 rpm Direct shank	0.6 kW–4.0 kW HF spindle up to 60,000 rpm Direct shank or HSK-E 25	0.6 kW–4.0 kW HF spindle up to 60,000 rpm Direct shank or HSK-E 25
Feed/ Positioning feed	Up to 28 m/min	Up to 22 m/min	Up to 22 m/min

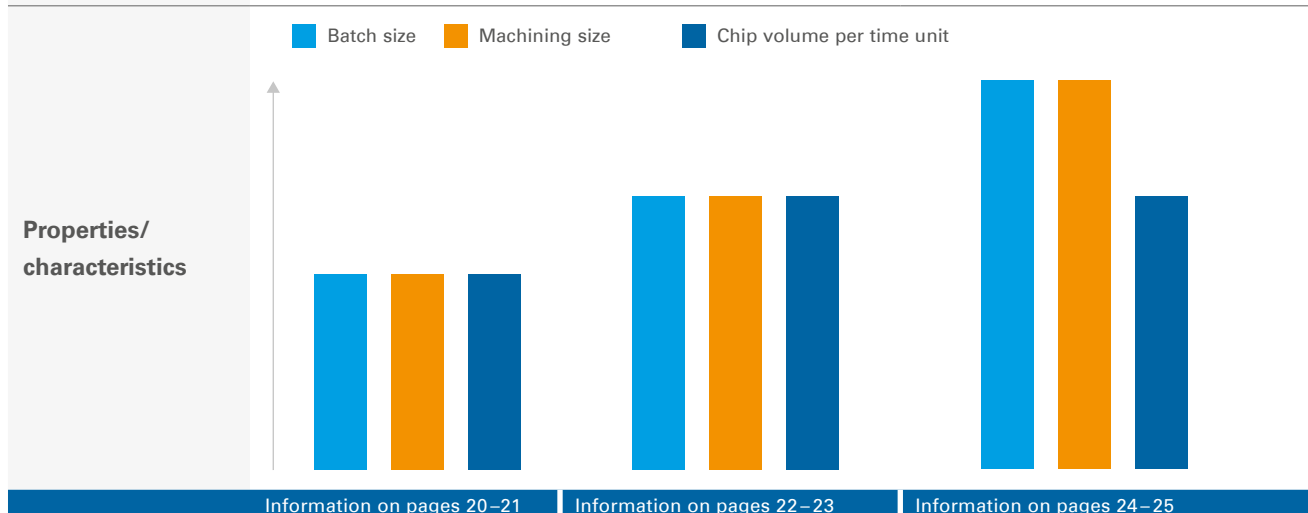

* Can be restricted by a tool changer in the Y direction from 100 mm to 200 mm.

Each application is different, and we offer the perfect solution for your particular requirements: whether you need 3, 3+2 or 5 axes simultaneously, a high level of precision or outstanding economy. Our experts will be happy to advise you and help you find the best, most efficient solution for your application.

MX Cube



18
19

& PROCESS RELIABILITY & POWERFUL

3+1

1,040 mm x 850 mm

205 mm

8.0 kW HF spindle
up to 34.000 rpm
HSK-E-32

Up to 40 m/min

■ Batch size
 ■ Machining size
 ■ Chip volume per time unit



Information on pages 28–29

** Where the optional automation solution is used.

DATRON neo

DATRON neo was specifically designed and purpose-built to give you an easy access to high-speed milling. This Plug-and-Play system features the new DATRON next software which gives you full control of 3-axis milling without requiring years of experience as a machinist. Ergonomic, frontal access to the work area allows for quick and safe setup of workpieces. With a Smartphone-like (touch screen) interface the command of fast and precise machining is literally at your fingertips. All of this and DATRON neo actually fits through a standard door!



Highlights

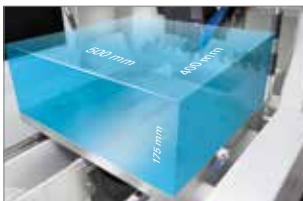

Ergonomic access to the work area from the front
Work area (X/Y):
500 mm/400 mm
Portal passage: 175 mm



24-station tool magazine
with integrated length
sensor for high flexibility
and precision



2 kW spindle and minimum-quantity cooling lubrication system
For burr- and residue-free
workpieces



3D measuring probe (XYZ sensor) and camera
For easy setup

Technical Data

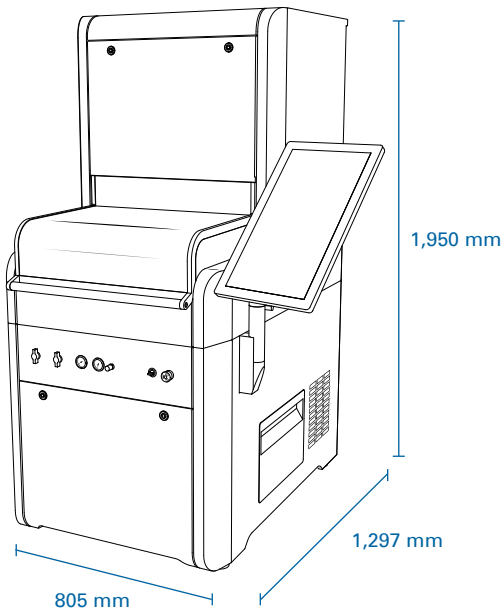

Full table
■ Machining area

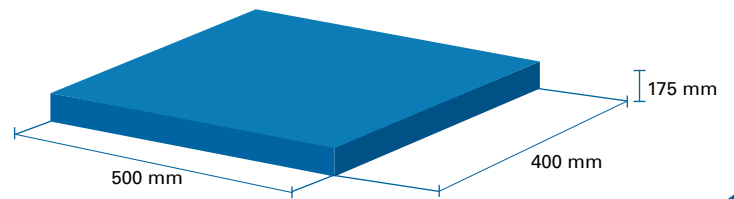

Use QR code for more information



20
21

	DATRON neo	DATRON neo+
Machining table	Portal construction, mineral-cast machine bed, aluminium table, steel stand	
Traverse path (X x Y x Z)	520 mm x 420 mm x 220 mm	
Working area (X x Y)	500 mm x 400 mm x 175 mm	
Portal passage	175 mm	
Installation dimensions without operating terminal (W x D x H)	805 mm x 1,290 mm x 1,880 mm	
Control system/software	DATRON next	
Operating terminal	24" multi-touch screen	
User-friendly hand-held control unit		✓
Drive system	Brushless digital servo drives; directly driven ball-screw spindle drives for each axis	
Rotary axis (4th axis)	Optional	
Minimum-quantity cooling lubrication system		✓
Machining spindle	2.0 kW HF spindle; up to 40,000 rpm, direct shank	
Tool magazine with length sensor	24 stations with direct-shank tool holding fixture	
3D measuring probe		✓
Feed	Up to 18 m/min	Up to 28 m/min
Positioning feed	Up to 18 m/min	Up to 28 m/min
Weight	Approx. 700 kg	

DATRON M8Cube

The DATRON M8Cube is the best choice for the cost-efficient machining of housings, profiles and front panels made of aluminium. But other non-ferrous metals and composite materials can also be machined extremely efficiently with the M8Cube. Short setup times, very low energy consumption and an outstanding price-performance ratio – even with small quantities – make it extremely economical to use.



Highlights

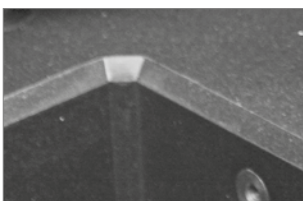

Solid, extremely flat, thermally stable polymer table.



High-precision spindle with concentricity better than 2µm and an HSK-E 25 tool holding fixture.



Smart control system: DATRON next lets you control the high-speed milling machine simply and intuitively by swiping.



Electrically controlled vacuum technology enables you to work very flexibly and cost-effectively thanks to very short set up times (connected immediately on being put in place).

Technical Data

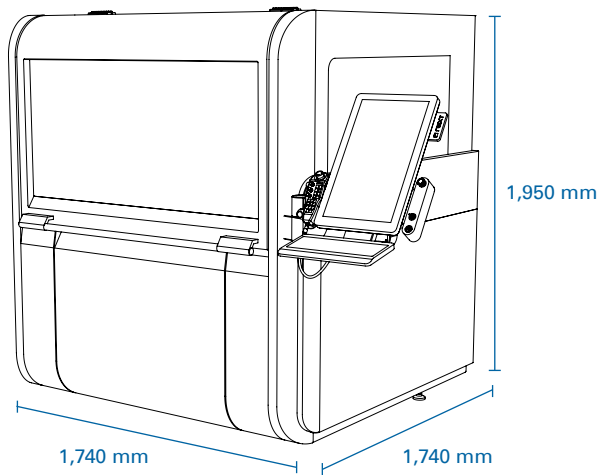

Use QR code for more information



Full table
■ Machining area

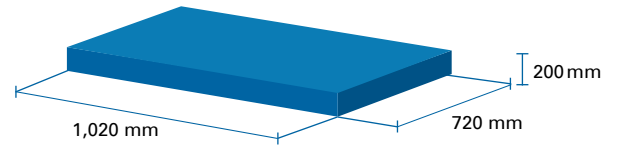
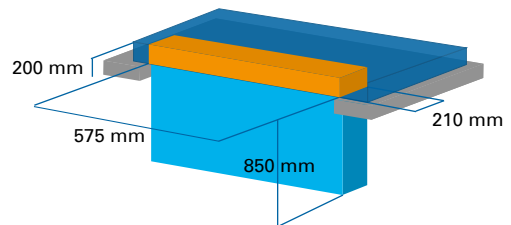

Table with breakout
■ Table
■ Machining area on the table
■ Machining area in the vertical clamping area
■ Max. space in the vertical clamping area



DATRON M8Cube

Machining table	Solid concrete polymer table with steel base, extremely rigid portal structure with double-sided Y drive with hidden guides
Traverse path (X x Y x Z)	1,020 mm x 830 mm x 245 mm
Working area (X x Y)	1,000 mm x 700 mm x 200 mm
Portal passage	200 mm
Installation dimensions without operating terminal (W x D x H)	1,740 mm x 1,740 mm x 1,950 mm
Tapered seat integrated in the table	✓
Control system	DATRON next control system
Operating terminal	24" multi-touch screen
User-friendly hand-held control unit	✓
Drive system	Brushless servo drives with absolute encoders; ball-screw spindle for each axis
Rotary axis (4th axis) or rotary swivel table (4th/5th axis)	Optional
Minimum-quantity cooling lubrication system	✓
Machining spindle	0.6 kW – 4.0 kW HF spindle, up to 60,000 rpm; direct shank or HSK-E 25
Tool changer	5 stations with HSK-E 25 tool holding fixture (10 stations optional) 12 stations with HSK-E 25 tool holding fixture (24 stations optional) 15 stations with direct shank tool holding fixture (30 stations optional) with integrated length sensor
Feed	Up to 22 m/min
Positioning feed	Up to 22 m/min
Weight	Approx. 1,300 kg

Large-format. Efficient.

DATRON

MLCube/MLCube LS

The DATRON MLCube is the best choice for cost-efficient sheet machining, for example to make front panels, housings, profiles and other aluminium workpieces that are milled in a sheet. Other non-ferrous metals or composite materials can also be machined extremely efficiently using the MLCube. Short setup times and the option of using different clamping techniques concurrently, very low energy consumption and an outstanding price-performance ratio – even with small quantities – make it extremely economical to use for many years.



Highlights



Solid, extremely flat, thermally stable polymer table.

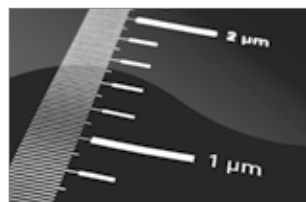

Linear measurement system (optional)



High-precision spindle with concentricity better than 2 µm and an HSK-E 25 tool holding fixture (optional).



Large working surface ideal for milling components combined in a sheet.

Technical Data

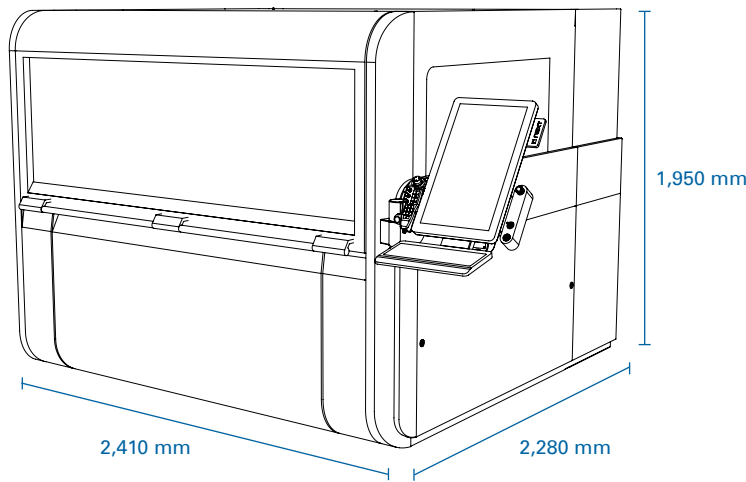

Full table
■ Machining area

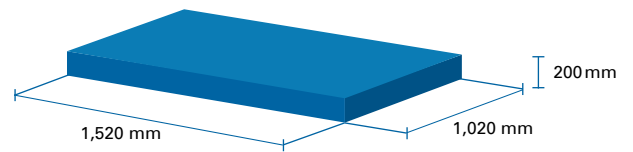
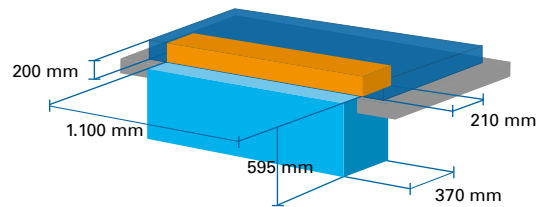

Table with breakout
■ Table
■ Machining area on the table
■ Machining area in the vertical clamping area
■ Max. space in the vertical clamping area



Use QR code for more information



	DATRON MLCube	DATRON MLCube LS
Machining table	Solid concrete polymer table with steel base, extremely rigid portal structure with double-sided Y drive with hidden guides	
Traverse path (X x Y x Z)	1,520 mm x 1,150 mm x 245 mm	
Working area (X x Y)	1,500 mm x 1,000 mm x 200 mm	
Portal passage	200 mm	
Installation dimensions without operating terminal (W x D x H)	2,410 mm x 2,280 mm x 1,950 mm	
Tapered seat integrated in the table		✓
Control system	DATRON next control system	
User-friendly hand-held control unit		✓
Drive system: Brushless servo drives with absolute encoders; ball-screw spindle for each axis		✓
Linear measurement system (X/Y)		✓
Rotary axis (4th axis)	Optional	
Minimum-quantity lubrication system		✓
Machining spindle	0.6 kW – 4.0 kW HF spindle up to 60,000 rpm; direct shank or HSK-E 25	
Tool changer	5 stations with HSK tool holding fixture (10 stations/15 stations optional) 12 stations with HSK-E 25 tool holding fixture (24 stations/36 stations optional) 15 stations with direct shank tool holding fixture (30 stations/45 stations optional) with integrated length sensor	
Feed	Up to 22 m/min	
Positioning feed	Up to 22 m/min	
Weight	Approx. 2,500 kg	

DATRON MXCube

With the DATRON MXCube we present the premium class of our high-speed portal machines. Its rigid structure, maximum dynamics and a powerful high-frequency spindle are ideal for modern HSC strategies and a high machining volume with an outstanding surface finish. The completely redesigned machine with optimised chip concept offers a wide range of functionalities for operation in an industrial environment.

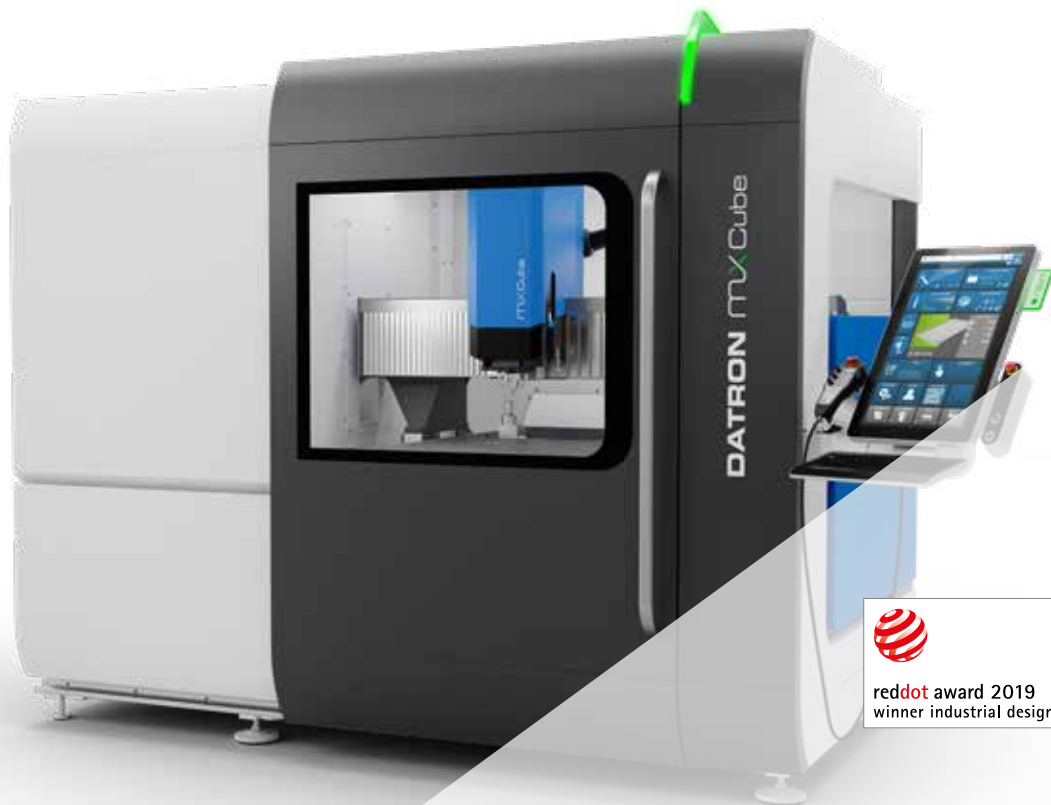

Highlights



Reliable **minimum-quantity cooling lubrication completely free from residues** during the machining process.



The vector-controlled **8 kW synchronous high-frequency spindle** with HSK-E32 provides a high machining volume over time.



Optionally available **combination of an XYZ sensor and camera** for a fast precise setup.



Steep angles on all sloping surfaces and a chip conveyor ensure **optimal chip removal**.

Technical Data

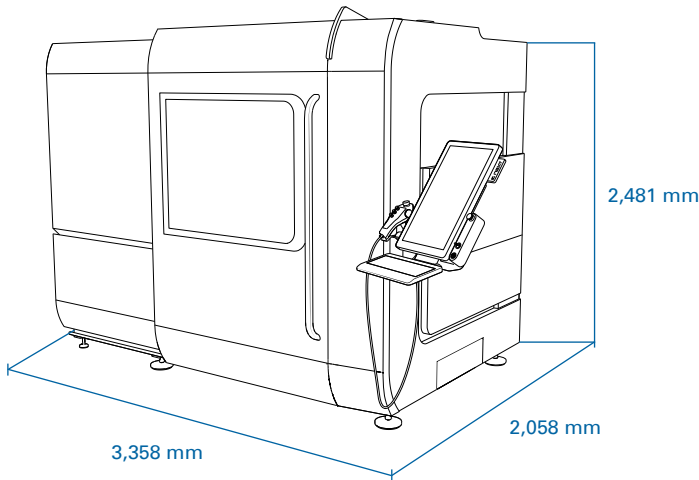

Use QR code for more information



Full table

■ Machining area

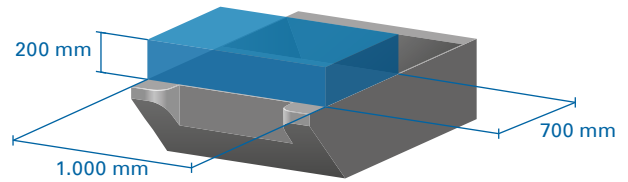

Table with breakout

■ Table

■ Machining area on the table

■ Machining area in the vertical clamping area

■ Max. space in the vertical clamping area

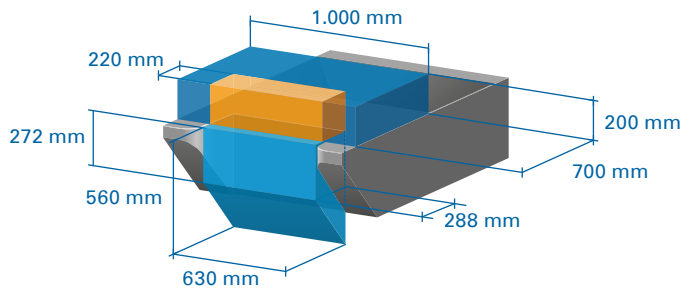

DATRON MXCube

Machining table made of mineral cast	Table types: + Full table + Table with breakout	Standard: + Integrated conical thread + Integrated vacuum and compressed air connections Optional: + Vacuum distributor
Traverse path (X x Y x Z)	1,040 mm x 850 mm x 270 mm	
Machining area (X x Y x Z)	1,000 mm x 700 mm x 200 mm	
Portal passage	205 mm	
Control system	DATRON next with 24" multi-touch operating terminal including keyboard	
High-frequency spindle	+ Power: 8.0 kW + Type: synchronous, vector-controlled + Speed (max.): 34,000 rpm + Tool insert: HSK-E 32	
Tool changer	+ Up to 110 tools + Tool diameter max. 24 mm	
Minimum-quantity cooling lubrication system	Optional + 4-nozzle spray ring + 9-litre coolant tank	+ Tool internal cooling lubrication + Second coolant tank (9 litres)
Positioning feed x/y	Up to 40 m/min	
Positioning feed z	Up to 28 m/min	
Direct absolute path-measuring systems	All axes	
Rotary axis (4th axis)	Optional	
Chip conveyor	Scraper conveyor, optional	
Dimensions (WxDxH) without terminal	2,702 mm x 1,859 mm x 2,481 mm	
Dimensions (WxDxH) with terminal, folded out	3,358 mm x 2,058 mm x 2,481 mm	
Weight	3,800 kg	



DATRON

HIGHLY DYNAMIC WITH OPTIMUM RIGIDITY

DATRON high-speed milling machines work with high-speed milling technology (HSC – High Speed Cutting). High spindle speeds of up to 60,000 rpm, a highly dynamic machine control system and a high feed rate deliver an outstanding surface finish and reduce production times. Thanks to their high spindle speeds, DATRON milling machines in many cases reach 5 to 10 times the cutting speeds of conventional milling machines.

The high-quality steel construction, designed for acceleration and rigidity, combined with a granite or concrete polymer work table, damps vibrations to optimum effect, resulting in impressive milling results.

- + Very high cutting performance with extremely small tools thanks to high-speed high-precision spindles operating at up to 60,000 rpm and with outputs of 0.6 kW to 8.0 kW
- + DATRON machines have a rigid, low-vibration structure thanks to reinforced concrete polymer or granite tables for an outstanding surface finish
- + High level of precision thanks to high-quality linear guides, ball-screw spindles, HSK-E 25/HSK-E 32 tool holding fixture (optional) and precision-manufactured structural elements



28

29

DATRON

HIGH-FREQUENCY SPINDLES

PowerS

Powerful and ultra-high-precision high-frequency spindles with HSK-E tool holding fixture. For outstanding quality and cutting performance.

PowerS Syncro 8.0 with 8.0kW and up to 34,000 rpm, HSK-E 32 tool holding fixture; liquid cooling

PowerS Syncro 3.0 with 3.0kW and up to 40,000 rpm, HSK-E 25 tool holding fixture; liquid cooling

PowerS Syncro 4.0 with 4.0kW and up to 40,000 rpm, HSK-E 25 tool holding fixture; liquid cooling

HighS

This universal spindle for high-speed milling, drilling and engraving is available in three different versions:

HighS L0.6 with 0.6kW and up to 60,000 rpm, direct-shank clamping; air cooling through spindle holder

HighS M1.8 with 1.8kW and up to 48,000 rpm; HSK-25 tool holding fixture

HighS H2.0 with 2.0 kW and up to 60,000 rpm; direct-shank clamping

EcoS

Particularly robust and cost-effective high-frequency spindle with direct-shank clamping and automatic tool changer. Speeds of up to 30,000 rpm with an output of 1.2kW.

It is particularly important to select the right spindle for your specific application when configuring your milling machine.

Our experts will be happy to advise you on which spindle is the best solution for you.



Precision in the Micrometre Range, Speeds of up to 60,000 rpm

DATRON has the right spindle for every machining application: from extremely high-performance, high-precision, high-speed spindles to robust and cost-effective “workhorses”

All DATRON high-frequency spindles are notable for their quality, precision and durability.

Spindle type Spindle power	Speed range (rpm)	Tool clamping method	Max. shank diameter/max. tool diameter for the automatic tool changer (mm)	Internal cooling	Cooling lubrica- tion system	neo	M8Cube/MLCube/LS	MXCube
 HighS L0.6 HF spindle, 0.6 kW	6,000 - 60,000	Direct-shank clamping	8/14	Air	DATRON cooling lubrication system		✓	
 EcoS P1.2 HF spindle, 1.2 kW	5,000 - 30,000	Direct-shank clamping	8/14	Air	DATRON cooling lubrication system		✓	
 DATRON neo HF spindle, 2.0 kW	4,000 – 40,000	Direct-shank clamping	8/14	Liquid cooling	Minimum-quan- tity cooling lubri- cation system	✓		
 HighS H2.0 HF spindle, 2.0 kW	6,000 - 60,000	Direct-shank clamping	8/14	Liquid cooling	DATRON cooling lubrication system		✓	
 HighS M1.8 HF spindle, 1.8 kW	5,000 - 48,000	HSK-E 25	10/20	Liquid cooling	Minimum- quantity cooling lubrication system, 5 l/9 l with filling level sensor		✓	
 PowerS Synchro 3.0 HF spindle, 3.0 kW	1,000 – 40,000	HSK-E 25	10/20	Liquid cooling	Minimum- quantity cooling lubrication system, 5 l/9 l with filling level sensor		✓	
 PowerS Synchro 4.0 HF spindle, 4.0 kW	1,000 – 40,000	HSK-E 25	10/20	Liquid cooling	Minimum- quantity cooling lubrication system, 5 l/9 l with filling level sensor		✓	✓
 PowerS Synchro 8.0 HF spindle, 8.0 kW	100 - 34,000	HSK-E 32	12/24	Liquid cooling	Minimum- quantity cooling lubrication system, 5 l/9 l with filling level sensor (optional with IKZ)			✓



The Accessories

DATRON

COOLING LUBRICATION SYSTEM





DATRON minimum-quantity cooling lubrication systems are the result of years of application experience. Depending on the coolant medium used, there is either only minimal residue or none at all. No cleaning, no degreasing – a significant advantage in many applications. The thermal energy generated during milling is removed through evaporation. In addition, the ethanol lubricates the tool's cutter, which increases its service life. The ethanol completely evaporates, and the workpieces therefore do not need to be cleaned following milling.



DATRON Cooling Lubrication System

DATRON minimum-quantity cooling lubrication systems can be used with different coolants/lubricants (e.g. ethanol, fatty alcohol, oil) and are designed for reproducible results in milling and engraving processes with particularly low quantities of liquid.

Two different spray head types are currently available: the round spray head for HSK-E 25 spindles with four nozzles for use with CleanCut and the spray head with four adjustable nozzles and a combined stream. This can be used with spindles with HSK and direct-shank clamping.

In addition, we offer an ethanol cooling lubrication system that is ideal for spindles with direct-shank clamping. The ethanol is sprayed onto the workpiece and tool through two nozzles during milling.



Use QR code for more information



DATRON

XYZ SENSOR



Easy camera-
assisted setup
More on this
on page 14

Fantastic in Every Way

The XYZ sensor is a three-dimensional tactile sensor. It considerably reduces the setup times of your milling machine and at the same time increases the accuracy and reliability of component referencing. Time-consuming setup thus becomes a thing of the past, making production significantly most cost-effective.

However, the key benefit is automatic compensation of workpiece height tolerances, resulting, for example, in perfect chamfering even with large parts, precise milling of recesses or deep surfaces and much more besides.

It's amazing how easy this DATRON tactile sensor can make the job for you.

How It Works

Simply swivel it into the work area and improve production quality or check dimensional accuracy in seconds: the XYZ sensor enables you to radically improve your production processes.



34

35

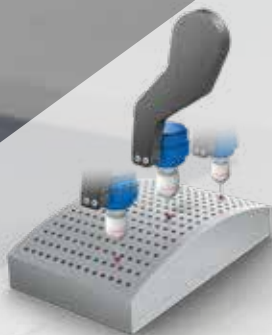

Workpiece Surfaces

The workpiece surface is surveyed by scanning it on a grid pattern. The CNC or engraving program is automatically adjusted during machining by the height profile created. You navigate quickly, simply and easily regardless of any uncertainties.



Corners and Edges

The edge of the material or the workpiece height can be ascertained accurately with a single measurement. With three measurements both the workpiece height and the exact position of a right-angled workpiece edge can be ascertained.

Key benefit:

Reference points on workpieces can be ascertained with much greater precision using the XYZ sensor and in a fraction of the time required using conventional methods.



Centre Points

Centre points of circular or rectangular islands or breakouts can be ascertained automatically.

Key Benefit:

Precise centring on the workpiece is possible in a few seconds without the need for a long setup time. An angular offset can be ascertained by measuring two reference holes, for example, and compensated by rotating the coordinate system.

DATRON

MODULE CLAMPING TECHNOLOGY

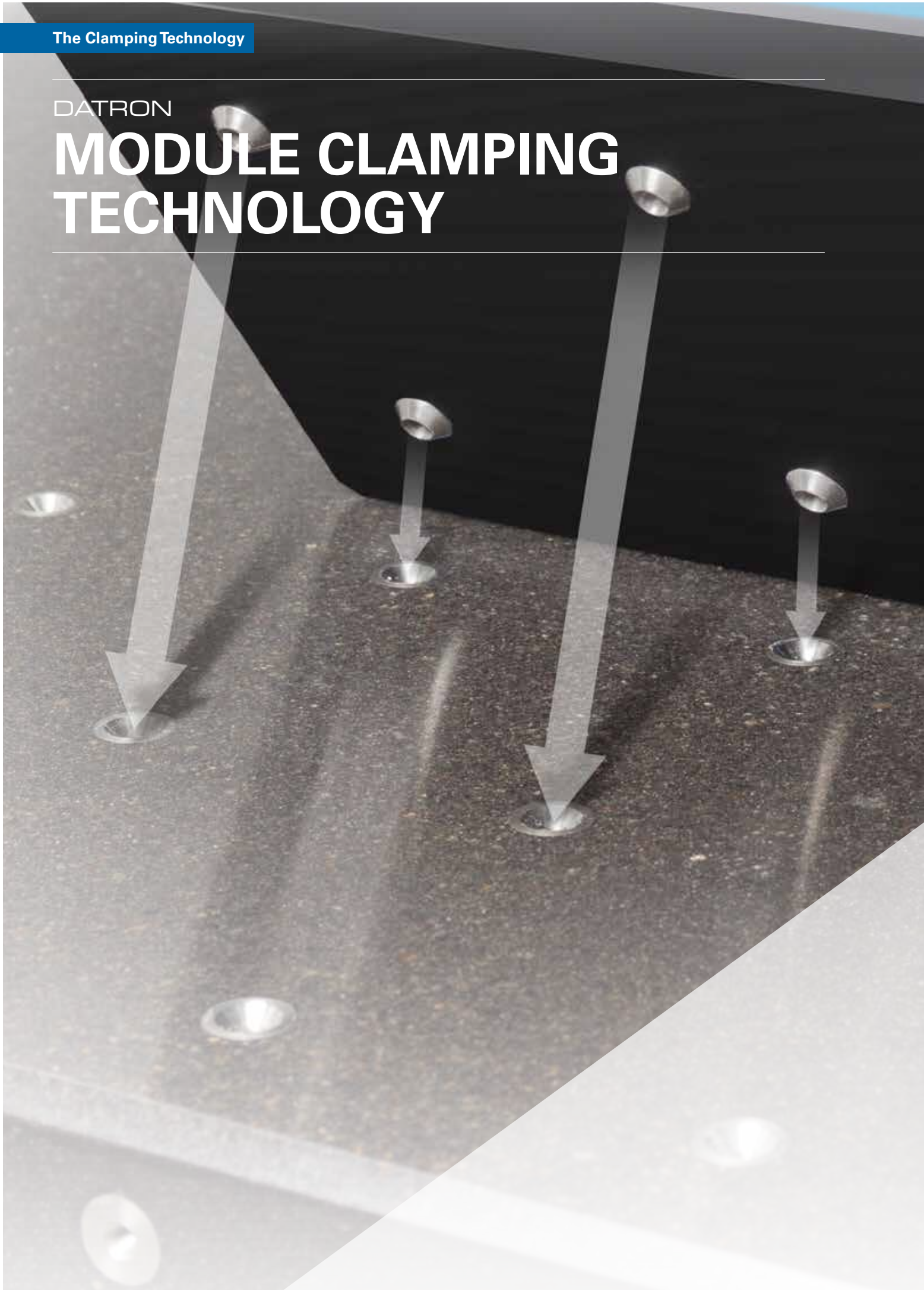

The End of Lengthy Setup Times and Laborious Bolt Tightening

Cost-effective production thanks to clamping within seconds: with DATRON module clamping technology, setup times can often be reduced considerably. The module plates are clamped directly onto the machining table by means of conical centring sleeves.

This applies to all machines with an integrated conical clamping system. The clamping modules can thus be changed very quickly, and the clamping position is highly reproducible.

DATRON offers a large number of finished module clamping solutions: vacuum module clamping plates or T-slots with a short-stroke clamping element, clamping chuck or bench vice. We are also happy to design custom clamping solutions. Benefit from our experience of hundreds of machine installations.

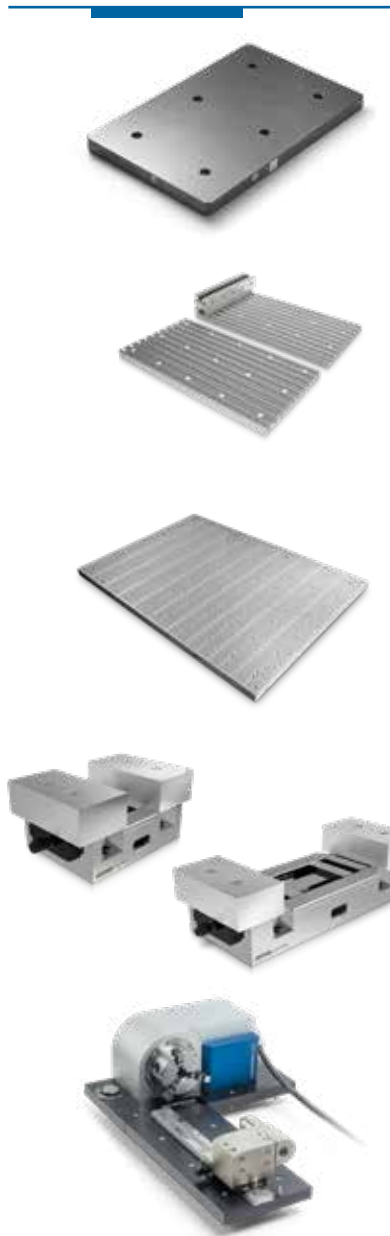

Module Clamping Plates

Clamping fixtures such as bench vices can be attached to the module clamping plates. The modules are attached to the machining table by means of screw fittings. Reproducible clamping stations can be created on these base plates and set up quickly when required.

T-slot Module Clamping Plates for Short-Stroke Clamping Elements, for example

The T-slot module clamping plate offers space for application-specific fastening solutions or the combination of a short-stroke clamping element and a fixed clamping jaw. The modules are screwed to the machining table.

Meander Plate

The DATRON meander plate is particularly suitable for clamping flat workpieces and sheet materials. Multiple identical or non-identical workpieces can be clamped. DATRON VacuCard is special cardboard that helps to distribute the vacuum under the workpiece and acts as a sacrificial layer. The meander plates are available in different sizes.

DATRON Compact Clamping Vice

The encapsulated DATRON compact clamping vice has full protection against contamination. Malfunctions as a result of contamination and chips that are clamped in are thus now consigned to the past. It is notable for its low height and high clamping force. It is available with a guide length of 160 mm or 300 mm. Optional aluminium clamping jaws allow different component geometries to be taken into account.

Compact Rotary Axis with Tailstock

The rotary axis is particularly suitable for multi-surface milling, circular engraving or radial drilling. It is fastened by means of DATRON module clamping technology. The rotary axis has no limit stop and offers a high level of precision and torsional rigidity.

The Clamping Technology

DATRON

VACUUM CLAMPING TECHNOLOGY





Plug and Play for Outstanding Ease of Use

Extremely simple and easy to use. Put the parts in place – and that's it! Even the smallest parts can be held thanks to the high holding forces of the DATRON vacuum plates. VacuCard++ patented special cardboard makes the perfect sacrificial layer.

All DATRON machines can be equipped with the DATRON vacuum clamping system. Thanks to a specially developed design, this has very high holding forces, even with shapes that are otherwise very difficult to clamp and the thinnest of sheet materials. The vacuum module clamping plates are available in different sizes and subdivided into segments that can be operated separately from each other.

Benefits

- + Very short setup times
- + Time-efficient sheet machining possible
- + Distortion- and vibration-free clamping of thin sheets
- + Complete milling around and separation of the workpieces possible

Applications

- + Clamping of sheet materials
- + Clamping of flat housings
- + Clamping of materials and shapes that are difficult to clamp

Vacuum Distribution

Connection Nozzles Integrated in the Table

Connection nozzles integrated in the table provide a direct connection to the vacuum plates. There are no hoses or tubes, which cuts the machine setup time significantly. In addition, less pressure is lost thanks to the much larger connection cross-section.

As soon as the vacuum plates are connected, they are automatically earthed. The connections can be controlled with ease from the CNC program; there is no need for connections to be made manually.



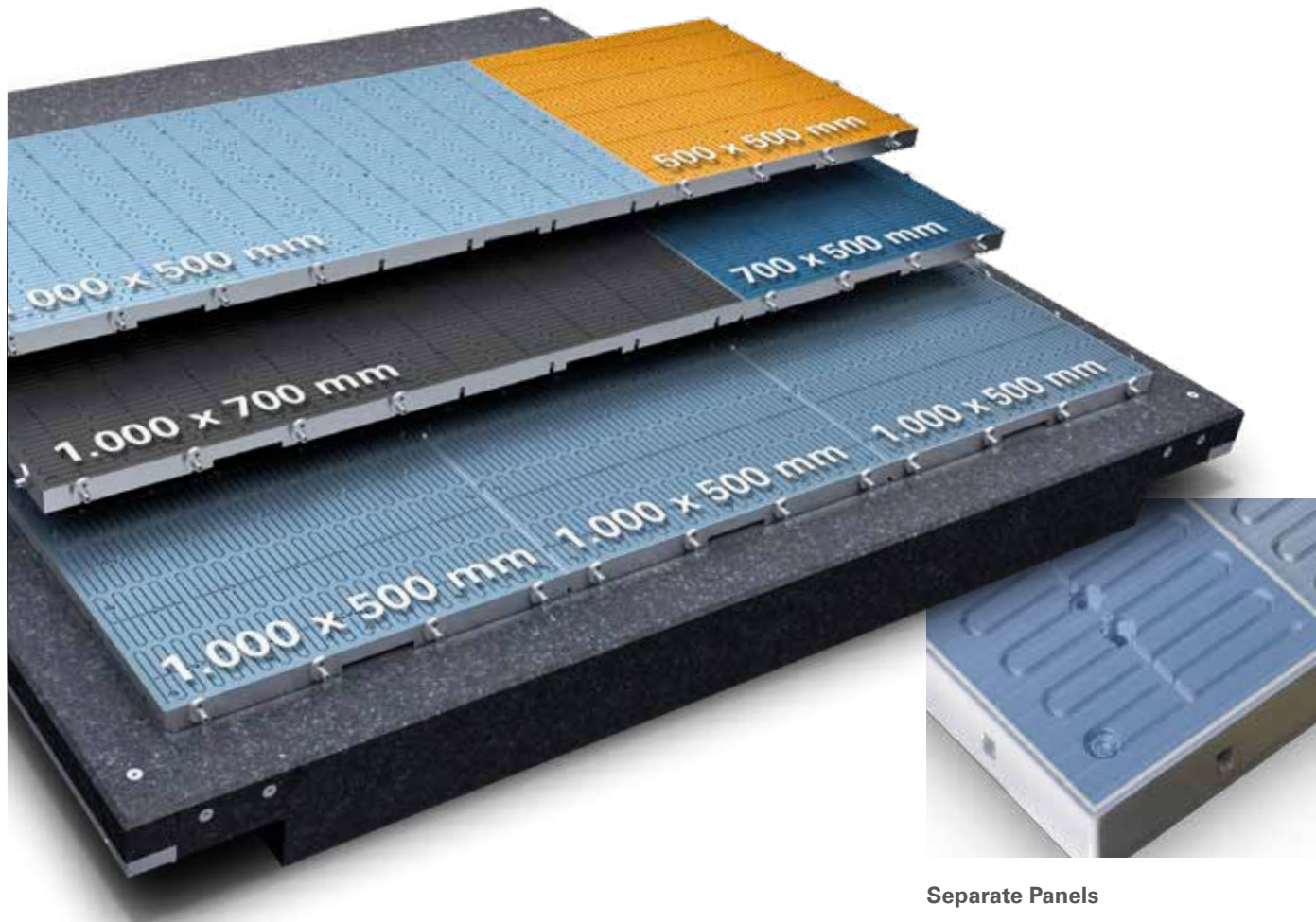

Separate Panels

To enable workpieces of all shapes and sizes to be clamped, DATRON offers vacuum plates subdivided into separate panels that can be activated, as appropriate, to suit each application. Pressure losses can thus be minimised.



Rollers

To permit the vacuum plates to be fitted more easily, 700 mm x 500 mm or larger plates have smooth-running rollers. These allow the plates to be positioned on the machining table with little effort. They also prevent the surface of the machining table from being damaged.



Recessed Grips

The vacuum plates have recessed grips to enable them to be handled safely.



Limit Stops

The workpieces can be aligned perfectly with the edges of the vacuum plates thanks to rotary limit stops. When the limit stops are lowered, the workpieces can be milled on all sides.

Plate Layout

DATRON MLCube Example: Table with Breakout

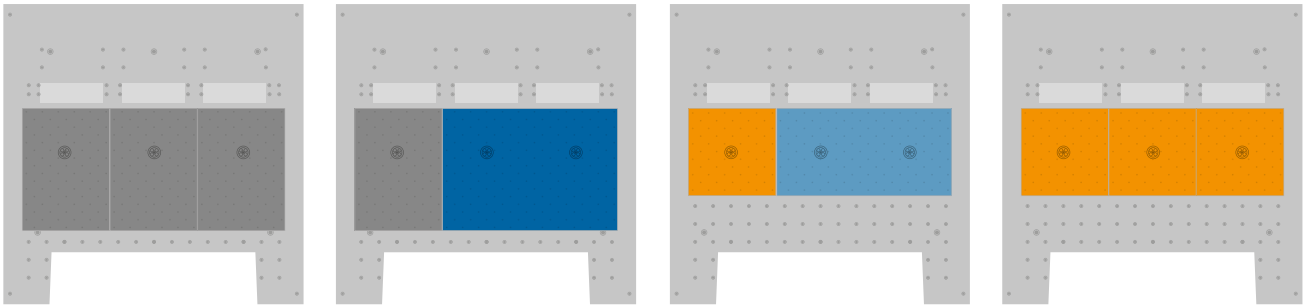

Variable Positioning

The DATRON table version with a breakout has three integrated vacuum connection nozzles. This permits variable positioning of the DATRON vacuum plates in sizes from 500 mm x 500 mm to 1,000 mm x 700 mm.



40

41

Plate Layout

DATRON MLCube Example: Full Table

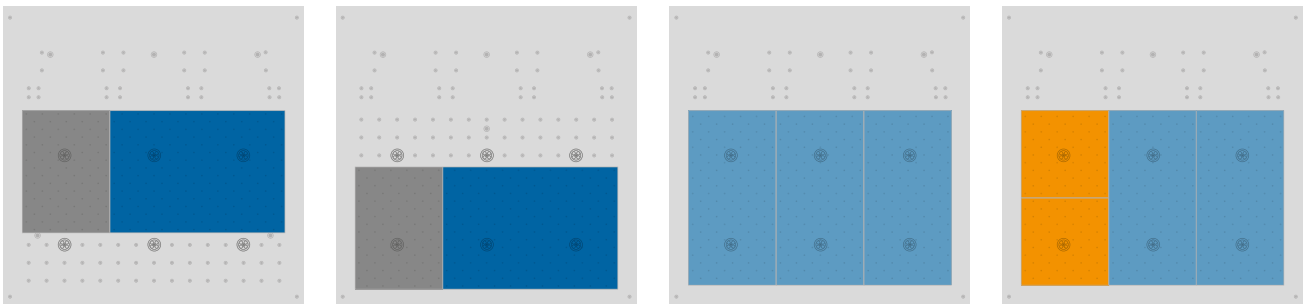

Full Flexibility

With six integrated vacuum connection nozzles, the DATRON full table offers numerous DATRON vacuum plate permutations. The plates can cover either the whole of the table or just part of it. In the latter case, there is space for additional clamping technology. The DATRON full table offers maximum flexibility for the implementation of different milling projects.

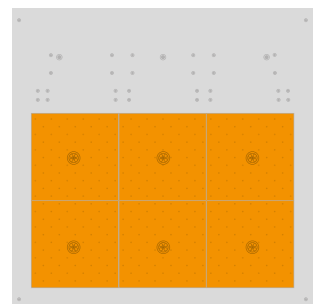

The Accessories

DATRON

SHORT-STROKE CLAMPING ELEMENTS





Rapid One-Handed Setup

Amazingly easy to operate at the touch of a button yet with a clamping force of up to 750 N. DATRON's short-stroke clamping elements are used wherever there is a demand for great flexibility and ease of use and short changeover times. The clamping elements are designed for use on a T-slot plate but can also be used as a stationary unit.



Advantages of DATRON Short-Stroke Clamping Elements

- + One-handed operation
 - + Rapid changeover
 - + Adjustable clamping pressure
 - + Compact design
 - + Automatic opening and closing
-

The Accessories

DATRON

CLEANCUT



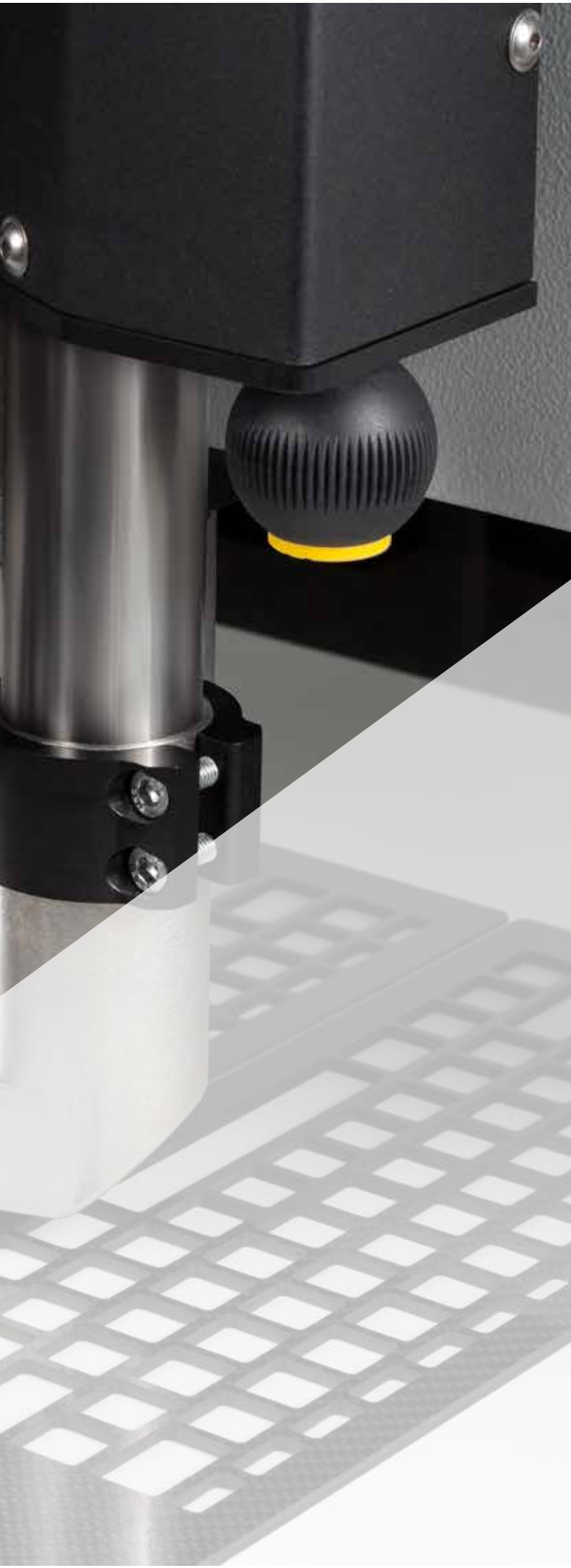

Saving Time and Working Cleanly with the CleanCut Suction System

The highly effective DATRON CleanCut suction system keeps the work area free of chips. Developed specifically for working with sheets, this suction technology permits virtually chip-free machining. It eliminates the need for a time-consuming machine-cleaning process.

Perfect for sensitive surfaces: the chips are removed without any contact being made. The automatic extension and retraction of the suction head saves further time.

Features:

- + Program-controlled swivelling in and out
- + Precise distance to the surface adjustable
- + Contact-free suction
- + Compatible with tool changer station and XYZ sensor
- + Automatic swivelling in and out with parking function
- + Compatible with direct-shank and HSK spindles
- + Minimum-quantity lubrication possible



DATRON

HIGH-SPEED TOOLS

For Profitable Milling, Drilling and Engraving

DATRON has been developing and supplying solid carbide tools of the very highest quality since 1990. As a manufacturer of high-quality, high-speed milling, drilling and engraving machines, we have paid close attention to developments in machining technology. The cost-effectiveness and quality of CNC machining depends to a large extent on the technical design and quality of our high-speed tools.

Take a look through our catalogue to get an overview of our current range. Based on our own development work and testing as well as the experience of our customers, we are able to offer you the best possible tools for high-speed machining.



Precision

- + From 0.1 mm for drilling
- + From 0.2 mm for milling
- + From M1 for thread milling



Quality

- + Development
- + Testing
- + Production



Cost-effectiveness

- + Max. cutting performance
- + Max. service life
- + Max. process reliability



Milling Tools for Aluminium

Dynamic

High-performance cutting, smooth operation and smooth surfaces: milling tools like the patented single-flute end mill with counterweight grinding, the DATRON milling countersink tool for creating holes and countersinks in a single step or our thread mills enable you to machine light metals profitably.



Milling Tools for Plastics/Composite Materials/Foams

Durable

Thanks to optimised chip removal, high-speed feeding is also possible for plastics without any melting or burr formation.

The single-flute end mill generation with polishing for plastics ensures a surface finish of the highest quality.

With DATRON's special tools for working with foams, outstanding surface finishes and sharp contours can be quickly achieved. The tools' durability is particularly outstanding.



Milling Tools for Steel and Similar Materials

Powerful

Stable cutter geometry and highly resilient coatings guarantee long service lives and cost-effective machining of materials.

Micro-double-flute end mills permit intricate milling, while three- and four-flute end mills are ideal for face and contour milling.

Four-flute ball-nose end mills are ideal for creating 3D free-form surfaces.



DATRON CUSTOMER SERVICE

The Added Value for You:

Our Services

- + Commissioning and machine installation
- + Hotline from 7 am to 6 pm
- + Software updates
- + Remote maintenance
- + On-site machine maintenance
- + Maintenance agreements
- + Spare parts service
- + Spindle replacement service
- + Logistics support
- + Machine retooling

You can get more information from our after-sales team.

Hotline +49 (0)6151-1419-999



From Installation to Years of Product Support: You Can Count on Us

DATRON ensures that its machines continue to operate to optimum effect – all around the world – even many years after they are purchased. Practice-oriented instruction and training enables you to exploit the full potential of your machines right from the outset. With state-of-the-art diagnostics tools and the in-depth expertise of our staff, we ensure that your production processes proceed without a hitch. Our proven spare parts service and customer-optimised maintenance program play a key role in minimising downtimes. When you buy a DATRON system, you get more than just a machine with a control system: you get a team of experts who give you comprehensive support.



Widely Distributed

We have a presence wherever we are needed. Where other companies represent us abroad, their service team is available to you locally. Short journeys save time and money: that's why DATRON offers several service centres in Germany as well as through many of our representative offices worldwide, of which there are over 20.



Expertise

Trained staff and many years of application experience and in-house practice guarantee the high quality of DATRON's service worldwide. As a result you get sound and competent advice and fast troubleshooting.



Friendly and Reliable

Our hotline helps you find solutions and fix problems, including for software- and programming-related issues. A comprehensive spare parts store ensures delivery times are kept to a minimum.



Cost-Effective

Teleservice, e-messaging, remote maintenance: we offer the latest data technologies for high-speed diagnostics and a cost-effective service.



DATRON

TECHNOLOGY CENTRE

Which machine is best for your production process depends on many different parameters. That's why in-depth technical consulting and the provision of samples are among our most important services.

Our professional consulting service is based on a precise analysis of your production challenge with the aim of optimising your entire production process.

We Offer You:

- + Product demonstrations of high-speed milling machines
- + Technology consulting on CAD/CAM selection, clamping systems and high-speed milling tools from DATRON
- + Customer-specific samples based on drawing data

DATRON

TECH ACADEMY

The DATRON Tech Academy will help you to learn to use your DATRON machine system efficiently and productively. The experienced, expert application engineers at our in-house technology centre in Mühlthal/Traisa will train you to use high-speed milling machines, tools and CAM strategies to optimum effect.

Thanks to the know-how and skills acquired by your staff, you will thus be able to exploit the full potential of your machine. Even if you are new to high-speed milling, we can provide you with an easy introduction or help you implement new ideas by means of practice-based examples and a clearly laid out programming and user interface.

Based on years of experience with our high-speed machine systems, we enable you relatively quickly, even if you have little experience of milling, to create your own product with our DATRON milling machines. Teaching people how to use our systems to optimum effect is very important to us, because we want to turn DATRON users into real fans.

The DATRON Tech Academy helps you along this path by offering suitable training for your DATRON machine systems and the applications you use them for. And our hotline staff are also available to answer any questions you may have after your training.

We can refresh the knowledge acquired in previous training or provide customised process support and work with you, taking advantage of your specific application know-how, to put in place even more efficient production programmes in order to further optimise your production.

Choose the kind of training you want from the list below, and request no-obligation information from the DATRON training catalogue today:

DATRON next

- + next basic
- + next advanced

Advanced Training

- + DST
- + PDA
- + Vision
- + Software options
- + DNC interface

Process Support

CAM Software

- + On request



DATRON

ABOUT US

DATRON AG

Dedicated Staff and Innovative Products

We develop, manufacture and distribute innovative high-speed milling machines for materials with a big future such as aluminium and composites, dental CAD/CAM milling machines for the efficient machining of all commonly used denture materials in dental laboratories, high-performance dispensing machines for industrial sealing and bonding applications and tools for high-speed machining. We also provide after-sales services such as training and customer support and sell accessories and spare parts.

Our products are all developed with a strong focus on customer benefit, have a very good price-performance ratio and low energy consumption and can be easily customised thanks to their lightweight modular design. To a very large extent, standard solutions can be customised to meet specific customer requirements.

Thanks to components that are designed to be compatible with each other and the resulting outstanding technical characteristics of DATRON products, production and automation processes can be decisively improved. This results not just in high production quality but also lower production costs.

DATRON's Core Products are:

High-Speed Milling Machines for Milling and 3D engraving

For milling, drilling and engraving aluminium, high-grade steel, plastics and composite materials. High production speeds and outstanding results are achieved at speeds of up to 60,000 rpm.

Dental CAD/CAM Milling Machine

DATRON D5, the ultra-compact 5-axis milling machine for NEM, zirconium oxide, glass ceramics, PMMA and wax. Automation with 8x blank changer and 15-station tool changer for industrial dental series production with high levels of reliability, speed and precision.

VDispenser® Dispensing Machine for Rapid, High-Precision Bonding and Sealing

The patented, world-leading dispensing technology is extremely accurate. Thanks to the quality and speed of the dispensing technology, there are significant cost benefits in series production.

Tools for High-Speed Machining

In high-speed machining, the quality of the tools is critical to the results obtained. Thanks to our technology and consulting expertise, our customers' production processes are more cost-effective than those of their competitors.

Technical Customer service

Training, service hotline, maintenance, sales of accessories and spare parts: professional support and expert consulting in all areas result in satisfied customers and have brought us the coveted "Deutschlands Kundenchampions" award (Germany's Customer Champions).

DATRON AG
Traisa Head Office

In den Gänsäckern 5
64367 Mühlthal
Germany

DATRON AG
Darmstadt Production
Facility
Delivery address
c/o Schenck TIP/Geb.37
Landwehrstraße 55
64293 Darmstadt

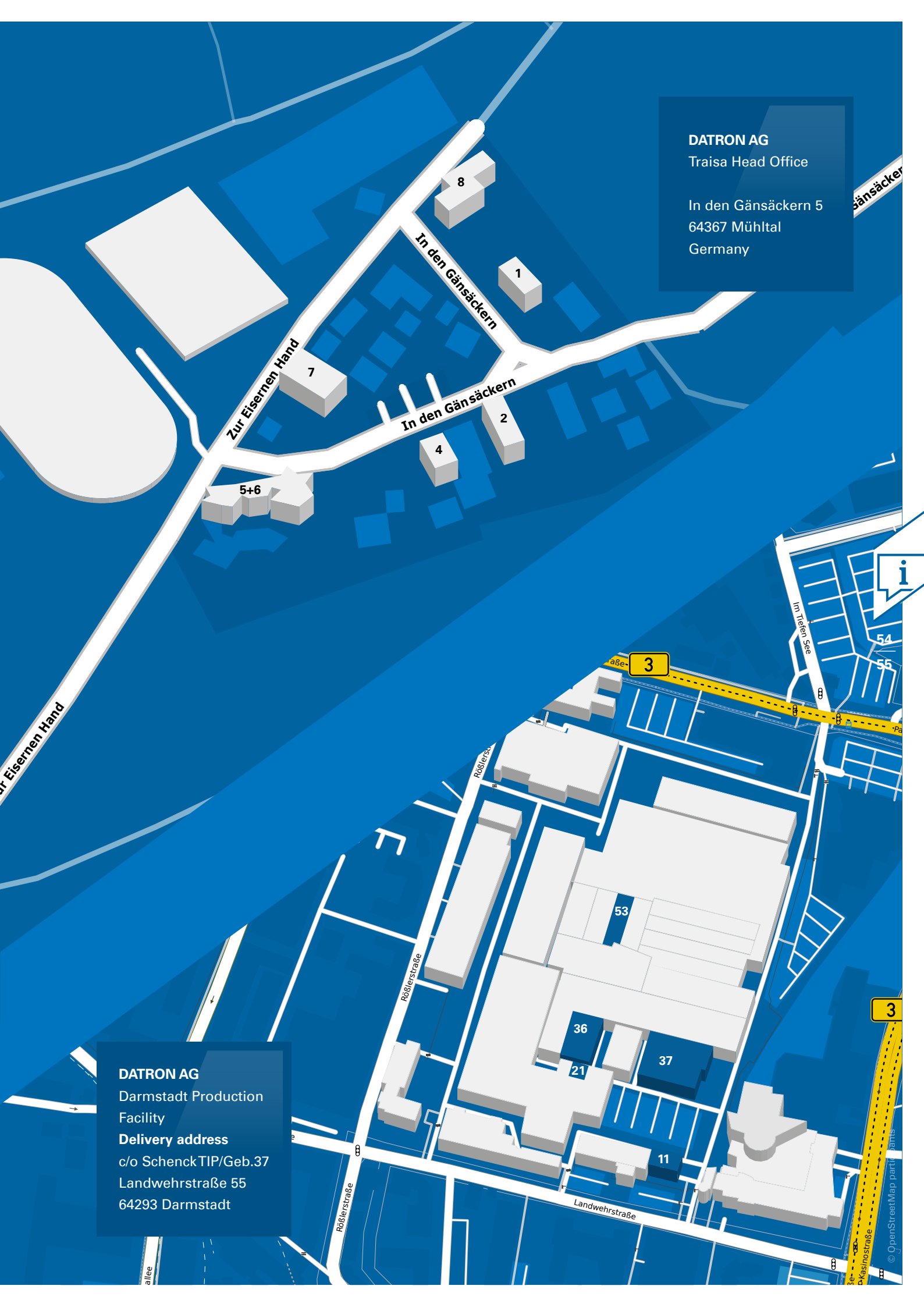

DATRON

RESOURCE- AND ENERGY-EFFICIENT



Example of the energy consumption of an M8Cube with a 3 kW milling spindle during aluminium milling

Component	Energy consumption
Milling spindle	1.3 kWh
Cooling unit	1.1 kWh
Other consumers	0.3 kWh
Total	2.7 kWh



Innovative Technology Made in Germany

The name DATRON is synonymous with state-of-the-art, high-quality, high-speed milling machines and tools. To enable us to always offer our customers the best possible solution and continually improve our products, we have experts working today on the production technologies of the future.

In close collaboration with universities and selected technology partner companies, DATRON is involved in numerous research projects aimed at bringing about innovative, more efficient production processes. Our innovativeness is demonstrated by numerous patents, and DATRON has been awarded the TOP100 seal of quality as one of the most innovative mid-sized companies in Germany.

Quality and customer satisfaction are our number one priorities. A key component of our company policy is to manufacture our products in Germany. DATRON products are developed exclusively in Germany and made of extremely high-quality components.

With our comprehensive, certified quality management system, we monitor and control all processes from product development to sales, delivery and service.

With innovative products from DATRON you will be able to build on your lead over your competitors. The key benefits to you are state-of-the-art machining technology, high quality and efficiency.

Saving Energy:

Very low consumption despite high milling volumes thanks to the use of energy-efficient technologies.

Saving Resources:

Minimum-quantity cooling lubrication system from 30 ml/hour. Very low cleaning outlay required.

Saving Space:

large working area with an extremely small footprint.

Energy-efficient machines and economical resource utilisation are playing an increasingly important role in production processes. Thanks to their innovative light-weight design and energy-efficient drive technology, DATRON machines are already cost-effective. DATRON milling machines consume less than 2.7 kWh on average, even when required to deliver a high level of cutting performance. In addition, the minimum-quantity cooling lubrication system developed by DATRON is an extremely cost-efficient, environmentally friendly solution.





We are glad to provide you with detailed information:
+49 (0)6151-1419-0



by E-Mail:
info@datron.de



or online at:
www.datron.de