

OPTIONAL ACCESSORIES

ROTARY AXIS WITH THREE-JAW CHUCK

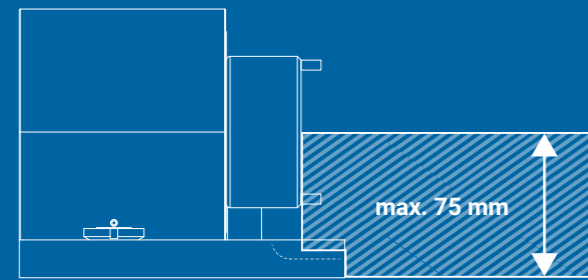

ROTARY AXIS WITH CENTRIC CLAMPING DEVICE

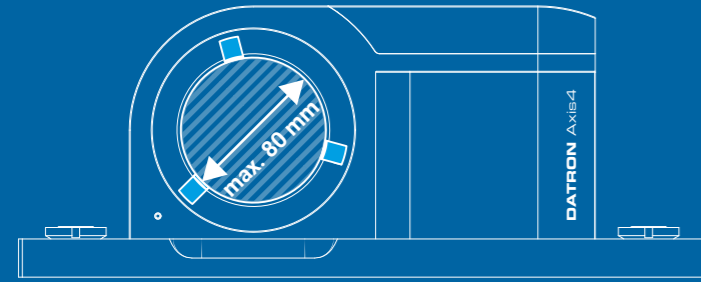
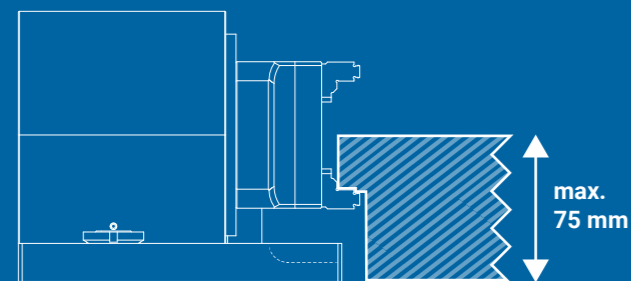
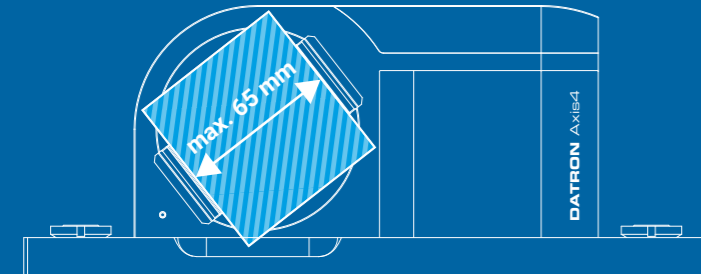

OPTIONAL ACCESSORIES

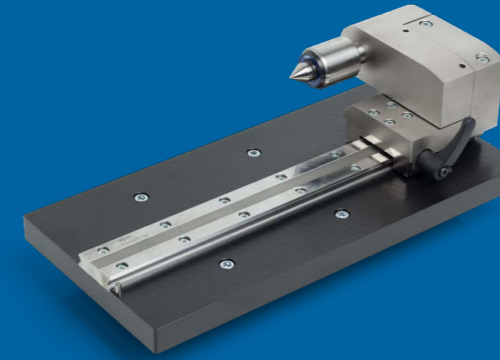

DATRON Axis4 three-jaw chuck
(item no. 0A03704C)

DATRON Axis4 centric clamping device
(item no. 0A03704D)

DATRON Axis4 tailstock
(item no. 0A03704B)

Technical data

Dimensions (D x H):
106 mm x 63.5 mm

Tip height:
55–75 mm

Clamping range
(jaws tapered to the inside):
2–80 mm

Clamping range
(jaws tapered to the outside):
25–78 mm

Inner bore (D x H):
19 mm x 40 mm

Clamping force (max.):
13 kN

Tightening torque (max.):
30 Nm

Dimensions (D x H):
106 mm x 80 mm

Tip height:
65–75 mm

Clamping range: 0–65 mm

Jaw width: 46 mm

Clamping force (max.) 6 kN

Tightening torque (max.):
30 Nm

Scope of delivery

Three-jaw chuck,
including mounting flange

1x set jaws tapered to the inside
made of case-hardened steel

1x set jaws tapered to the outside
made of case-hardened steel

Lathe chuck spanner

Centric clamping device,
including mounting flange

Clamping key

Tailstock,
including module clamping plate

Live lathe centre (D 18 mm)

Dimensions (L x W x H):
329 mm x 160 mm x 98 mm

Tip height (max.):
55 mm

Tip width (depending on application)

Seat: MK2

Diameter of lathe centre (max.):
65 mm

DATRON_Axis4_Prospect_04/12/2018_EN_V0.1

DATRON AG
In den Gänsäckern 5
64367 Mühlital, Germany

+49(0)6151-1419-0
info@datron.de
www.datron.de

www.datron.de

© 2018 DATRON AG - All rights reserved, as of: October 2018
liability-exclusion.datron.de

DATRON
Smart Manufacturing Solutions

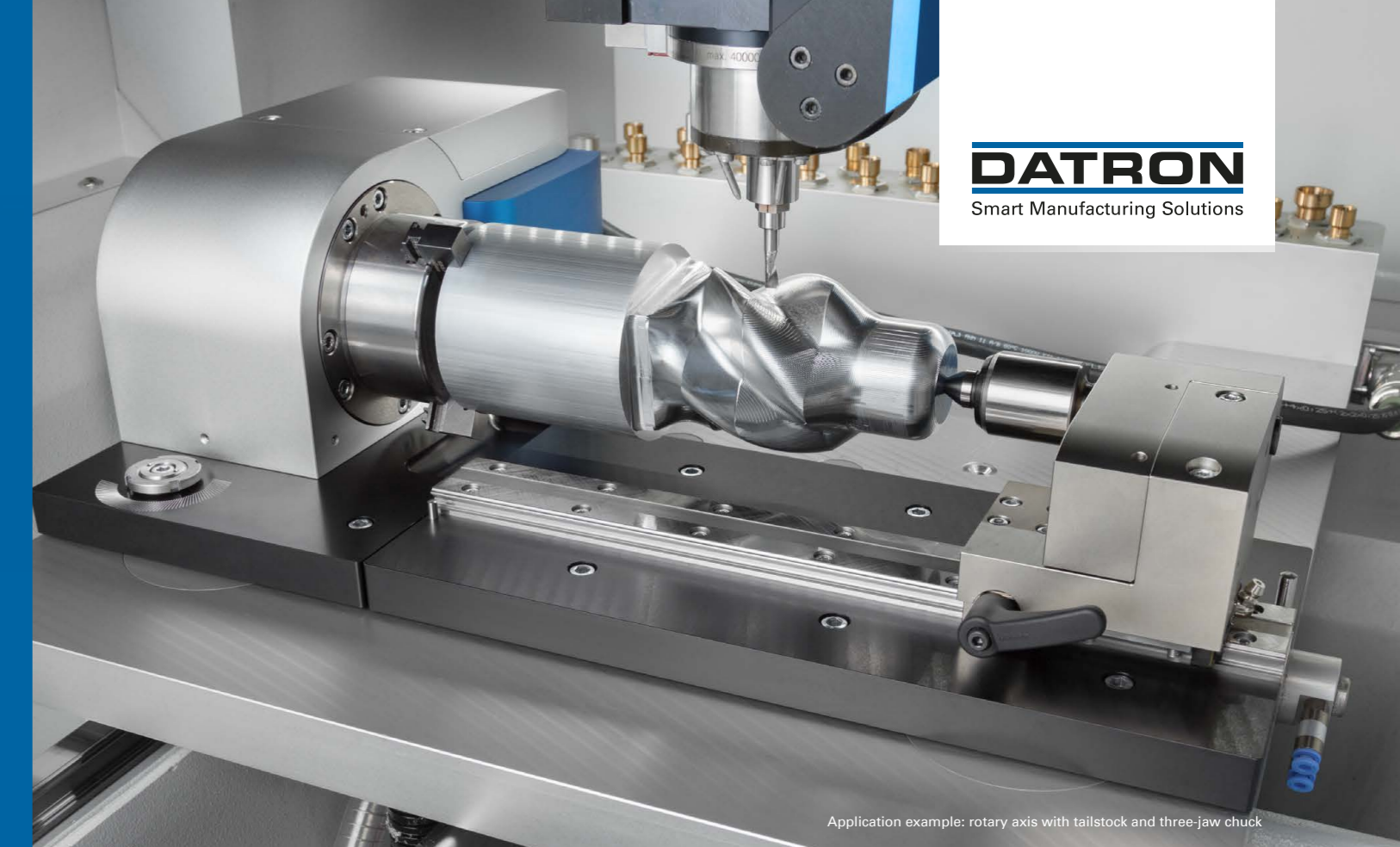

Application example: rotary axis with tailstock and three-jaw chuck

DATRON Axis4 Dynamic and Precise Fourth Axis

The DATRON Axis4 rotary axis expands the machining options of your DATRON milling machine. With a clamping mechanism, it allows multi-sided machining and circular engraving. Developed, tested and manufactured by DATRON, the rotary axis, with high dynamics and precision, is perfectly adapted to your DATRON milling machine.

PRODUCT FEATURES

- For more options:
multi-sided machining, circular engraving
- Dynamics and precision for excellent results
- Flexible use with optional accessories: three-jaw chuck, centric clamping device, tailstock
- Precise alignment with the XYZ sensor (optional)
- Easy positioning on the table
with modular clamping technology
- Simple switchover between a 3-axis and 4-axis machine
- Plug-and-play connection in the working area

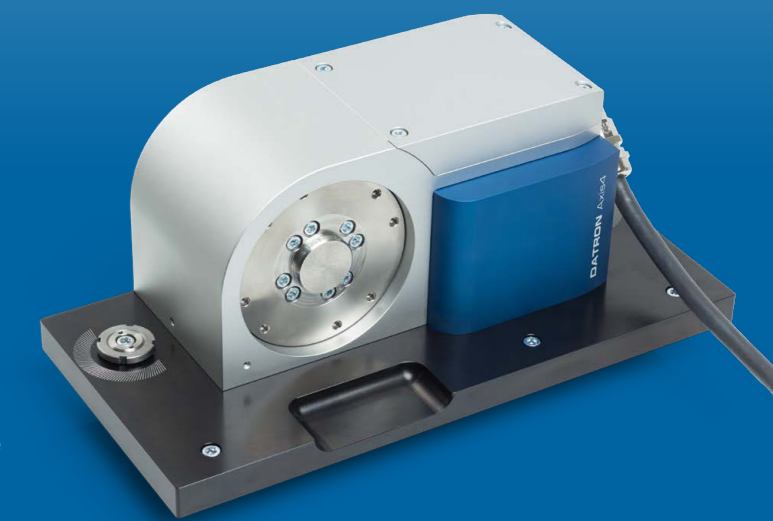

TECHNICAL DATA

Technical data	
Tip height	55 - 75 mm (depending on the accessories and part geometry)
Seat	Plane surface with D=106 mm and centric fit (34h6)
Drive	200W AC servo with multi-turn absolute value encoder
Gear	Cycloid gear free from backlash
Reduction	79
Swivel range	Continuous rotary operation
Mounting direction	A-axis
Resolution	< 0.0001°
Positioning accuracy (P*) refers to VDI 3441	120 arcsec
Repeat accuracy (Ps mean) refers to VDI 3441	30 arcsec
Tilting torque with application without tailstock (max.)	10 Nm (from face contact)
Work piece weight with application with tailstock (max.)	35 kg (note maximum table load)
Speed (max.)	60 rpm
Dimensions (XxYxZ)	170 mm x 360 mm x 142 mm
Weight (rotary axis)	Approx. 9.5 kg
Weight (with tailstock and three-jaw chuck)	Approx. 19 kg

Scope of delivery

Rotary axis on module clamping plate	
Rotary axis control system	DATRON neo (in separate control cabinet), M8Cube, MLCube, MXCube, M10 Pro (integrated in machine control cabinet)
Short-circuit plug for three-axis operating mode	
Adapter cable	only M8Cube, MLCube, MXCube, M10 Pro

System requirement

Machine type	DATRON neo, M8Cube, MLCube, MXCube, M10 Pro
Control system	DATRON next

ITEM NUMBERS

DATRON machine type	DATRON Axis4 rotary axis	Preparation power amplifier and wiring
neo	0A03704I	0A03704K
neo+	0A03704I	0A03704L
M8Cube	0A03704I	0A03704F
MLCube	0A03704I	0A03704F
MXCube	0A03704I	0A03704G
M10 Pro	0A03704I	0A03704H

There may be restrictions when using the rotary axis on all machine systems with a suction unit. Please see the operating instructions.

APPLICATION EXAMPLE 1: ROTARY AXIS WITH TAILSTOCK

RECOMMENDED DISTANCE FROM ROTARY AXIS¹

Machine type	Tip width with recommended configuration:	Additional accessories possible?	
		Vacuum plate	Bench vice or other
DATRON neo/neo+	max. 210 mm	×	×
DATRON M8Cube	max. 210 mm	✓ (max. 500 x 700 mm)	✓
DATRON M8Cube with cut-out section	max. 210 mm	✓ (max. 500 x 500 mm)	✓
DATRON MLCube	max. 210 mm	✓ (max. 1,000 x 1,000 mm)	✓
DATRON MLCube with cut-out section	max. 210 mm	✓ (max. 1,000 x 700 mm)	✓
DATRON MXCube	max. 210 mm	✓ (max. 500 x 700 mm)	✓
DATRON MXCube with cut-out section	max. 210 mm	✓ (max. 500 x 500 mm)	✓
DATRON M10 Pro	max. 210 mm	✓ (max. 500 x 700 mm)	✓
DATRON M10 Pro with cut-out section	max. 210 mm	✓ (max. 500 x 500 mm)	✓

¹This arrangement is required to align the tailstock to the rotary axis.

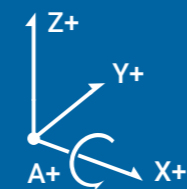
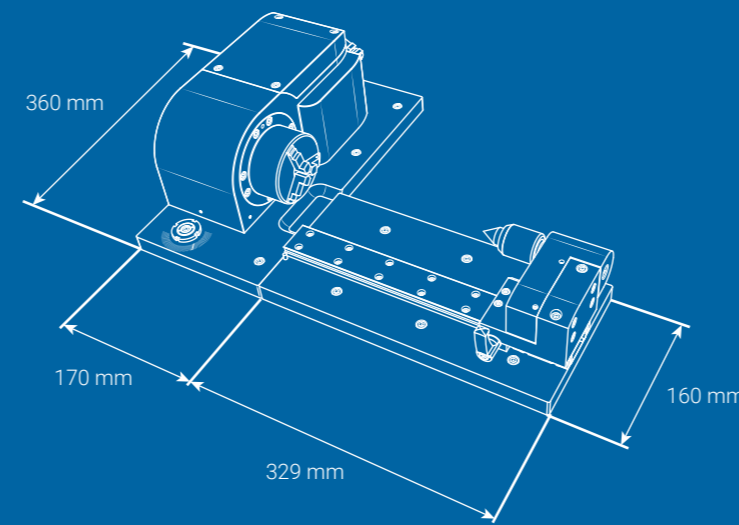
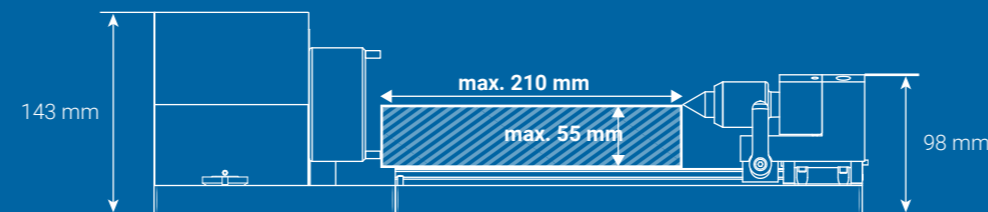

APPLICATION EXAMPLE 2: ROTARY AXIS WITH TAILSTOCK

MAXIMUM DISTANCE FROM ROTARY AXIS²

Machine type	Tip width with expanded configuration	Additional accessories possible?	
		Vacuum plate	Bench vice or other
DATRON neo/neo+	×	×	×
DATRON M8Cube	max. 710 mm	×	only with restrictions
DATRON M8Cube with cut-out section	max. 710 mm	×	×
DATRON MLCube	max. 1,210 mm	✓ (max. 1,000 x 500 mm)	✓
DATRON MLCube with cut-out section	max. 1,210 mm	✓ (max. 1,000 x 500 mm)	✓
DATRON MXCube	max. 710 mm	×	only with restrictions
DATRON MXCube with cut-out section	max. 710 mm	×	×
DATRON M10 Pro	max. 710 mm	×	only with restrictions
DATRON M10 Pro with cut-out section	max. 710 mm	×	×

²The tailstock must be aligned to the rotary axis at the recommended distance beforehand.

